XL-1S

SECURITY SYSTEM

HOOKUP AND INSTALLATION INSTRUCTIONS



FIRE BURGLARY INSTRUMENTS INC.
Subsidiary of Pittway Corp.
149 Eileen Way, Syosset, NY 11791

THANK YOU for your purchase of the FBII XL-1SILVER.

The purpose of the manual is to give you a brief overview of the XL-1S control panel, and provide instructions for installing a basic system. FBII is always available to serve YOU. Our SALES and TECHNICAL SUPPORT staff are available to assist you in any way possible.

<p>FOR TECHNICAL SUPPORT, CALL TOLL FREE: (800) 645-7492</p>
--

Before you call Technical Service, be sure you:

- Check the wiring diagram and verify your connections.
- Check all fuses.
- Assure that the transformer and backup battery voltages are supplying the proper voltage levels.
- Verify your programming information.
- Read this manual thoroughly.
- Consult the Troubleshooting Section of this Manual.
- Note the proper model number of this product, and the version level (if known) along with any documentation that came with the product.
- Have your company name and telephone number ready.

This information will allow us to service you more quickly and effectively. Please, remember to BE PATIENT while waiting on the telephone; your call will be answered as soon as possible.

FOR YOUR CONVENIENCE, a System Planning Worksheet and a Programming Worksheet is included at the back of this manual. These can be removed to help you record account information.

Table of Contents

.....

XL-1S to XL-2 Comparison	v
Conventions Used in This Manual	vii
Section 1 - Introduction	1-1
Section 2 - System Wiring and Hookup.....	2-1
System Wiring Diagram	2-1
Terminal Connections	2-2
Auxiliary Device Current Draw Worksheet	2-6
Wiring Information for Keypads & Other Devices.....	2-7
Keypads & Other Devices.....	2-7
Section 3 - PC Board Mounting.....	3-1
Mounting the PC Board	3-1
Section 4 - Keypad Mounting.....	4-1
XK-104 Keypad.....	4-1
Mounting 6805 Keypad.....	4-2
Section 5 - Keypad Layout.....	5-1
Keypad Sounder	5-3
Section 6 - System Operations.....	6-1
Power Up/System Reset.....	6-1
Arming the System.....	6-1
Stay Arming.....	6-1
Instant Arming.....	6-1
Stay/Instant Arming	6-2
Disarming	6-2
Reset.....	6-2
Bypass	6-2
Auto Unbypass	6-3
Manual Unbypass	6-3
User Code Programming.....	6-3
User Deletion.....	6-4
Keypad Emergency Conditions	6-4
Section 7 - Installer Modes.....	7-1
Installer Mode 1 (Installer Keypad Programming).....	7-1
Installer Mode 2 (System Log View)	7-1
Installer Mode 3 (Unattended Download)	7-2
Installer Mode 4 (On-Line Download)	7-2
Section 8 - System Programming	8-1
General.....	8-1
Programming Questions	8-1
Zone Programming.....	8-10
Section 9 - Data Entry via LED & LCD Keypads	9-1
Entering Programming Mode via Either LED or LCD Keypads	9-1
What You See on the LED Keypad	9-1
What You See On The LCD Keypad	9-2
How to Enter Data	9-2

Table of Contents (cont'd)

.....

Section 12 - System Defaults	10-1
Section 11 - Summary of Keypad Functions	11-1
User Functions	11-1
Installer Mode	11-1
Appendix A - Central Station Reporting Formats	A-1
Standard (3X1)	A-1
4X2.....	A-2
Appendix B - Troubleshooting	B-1
Appendix C - XL-1S System Planning Worksheet	C-1
Appendix D - XL-1S System Programming Worksheet	D-1
Appendix E - Warnings and Limitations	E-1
Appendix F - FCC Statement and Telephone Problems	F-1
Appendix G - Warranty	G-1

XL-1S to XL-2 Comparison

The XL-1S is an enhanced version of the XL-2 control panel. Some new features have been added and others have been modified. The following is a quick comparison.

XL-1S NEW & MODIFIED FEATURES

Call Waiting /PBX Dialing - 1 digit entry (program quest. #01 & #02)

Smoke Power or Programmable Trigger #1 Output/Terminal P1-T1 (program quest. #07)

Programmable Trigger #2 Output/Terminal P1-T2 (program quest. #07)

CS Test Timer Offset (program quest. #14)

Cancel Code (program quest. #18)

European Ring Detect (program quest. #05)

Exit Error Warning (always enabled)

Bypass In Stay - Any Controlled Zone can be Bypassed in Stay Mode (program quests. #10-13)

System Stabilization on Power Up - to Eliminate Motion Detector False Alarms

Fast Loop Response (10 msec) Option by Zone (program quests. #10-13)

AC (50/60 HZ) Based System Real Time Clock (program quest. #05)

Bell Supervision - New NFPA 72 Requirement (program quest. #13)

Stay Mode 40 Sec. Dialer Delay w/Bell & Keypad Sounder Warning for All Zones (program quest. #05)

LED Zone Display & Keypad Sounder during Entry (always enabled)

XL-1S FEATURE CHANGES

5 Zones - 4 Programmable & Wired Panic or Keyswitch Zone (program quest. #10-13)

System Wide Restore Code Enable (program quest. #19)

System Wide 15 Sec. Dialer Delay for controlled zones (program quest. #07)

User 5 - Arm Only User capability removed

XL-2 SIMILAR FEATURES

Multiple digits required

Smoke Power Only

NONE

NONE

NONE; Restore Code Only

NONE

NONE

Interior Zones Only Bypassed in Stay Mode

NONE

NONE

Software Based System Timing

NONE

Stay Mode Entry Delay w/Keypad Sounder Warning for Exit/Entry Zones Only

Keypad Sounder Only

XL-2 SIMILAR FEATURES

7 Zones - 6 Programmable & Wired Panic or Keyswitch Zone

Restore Codes selectable by each zone

15 Sec. Dialer Delay selectable by each zone

User 5 - Arm Only User optional

XL-1S to XL-2 Comparison (cont'd)

Ring Count Options: 0, 4, 8, 12, (program quest. #07)

Quick Commands (Quick Arm, Quick Forced Arm & Quick Bypass) capability removed

= Reset (* key) always enabled for Fire Alarms Only

LCD Keypad Descriptors NOT Programmable (Default = Zone 1, Zone 2, etc.)

CS Reporting Formats (Ext. & Partial Ext.) capability removed

CS Test Keypad Ringback always Silent

Ring Count Options: 0 - 15

Quick Arm & Quick Forced Arm/Quick Bypass programmable

Reset (* key) programmable for Both Burglar & Fire Alarms

LCD Keypad Descriptors Programmable

CS Reporting Formats (Ext. & Partial Ext.) programmable

CS Test Keypad Ringback always Audible

Conventions Used in This Manual

Before you begin using this manual, it is important that you understand the meaning of the following symbols (icons).

UL

These notes include specific information which must be followed if you are installing this system for a UL Listed application.



These notes include information that you should be aware of before continuing with the installation, and which, if not observed, could result in operational difficulties.



This symbol indicates a critical note that could seriously affect the operation of the system, or could cause damage to the system. Please read each warning carefully. This symbol also denotes warnings about physical harm to the user.

Introduction

.....

The XL-1S Security System is a state of the art microprocessor-based control/communicator. Programming can be performed through any of the compatible keypads or the system can be uploaded and downloaded remotely using the EZ-Mate PC Downloader Software. In addition, remote control actions (arming, disarming, bypassing, etc.) can be performed by the software. Programming options are stored in non-volatile reprogrammable EEPROM memory and that information which has been programmed will not be lost in the event of a complete loss of power. Other features of the XL-1S include:

- 5 Zones (4 fully programmable plus a wired panic zone or keyswitch zone)
- 2 types of compatible keypads (LCD & LED, four wire devices with up to four per system)
- 6 user codes with capability for ambush code
- Fast Loop Response (10 msec) selectable by zone
- NFPA 72 Bell Supervision
- CS Test Timer Offset
- English readout keypads available
- Upload/Download with remote commands with answering machine bypass
- Default Lockout option to prevent hostile account takeovers
- Indications on keypad for AC loss, Low Battery and Communication Failure
- Central Station reporting for Alarms, Troubles, Restores, Bypasses, Openings, Closings, Ambush, Panic, 24HR. Test, Cancels, AC loss, and Low Battery
- Can be programmed as a Local System (No CS Reporting)
- 4 wire smoke detectors with Fire Verification logic plus smoke power reset
- Exit Error Warning
- European Ring Detect
- 2 programmable trigger outputs for various functions (including armed/ready indication and glass break detector reset)
- Input Power: 12VAC 20VA; 12VDC, 4 - 7 AH
- Output Power: 11.5 - 13.1VDC, 500mA
- Bell Output Power: 10 - 15.5VDC, 1A

System Wiring and Hookup

System Wiring Diagram



CONNECTIONS FOR HOUSEHOLD FIRE/BURGLAR ALARM SYSTEM

XL-1S

ZONE	TERMINALS	
	(+)	(-)
1	1	2
2	3	2
3	4	5
4	6	5
PANIC	7	5

NOTES:

1. Connect to a grounded metal water pipe (16ga. at 15 ft.)
2. Total AUX. power available (including keypad power) is 500mA max (300mA max for UL installations). Used for connection of devices rated from 11.5 to 13.1VDC.
3. System must be tested on a weekly basis. For information, refer to manual.
4. Do not connect the transformer to a switch controlled receptacle. Power varies with transformer (SEE NOTE 2).
5. Installation of equipment and wiring methods are required to be in accordance with the National Electrical code and ANSI/NFPA No. 74.
6. Battery capacity for Emergency Standby is a minimum of 4 hours. Under normal conditions this battery will last 3 years. Use only exact replacements.
7. Maximum of 4 keypads. Available keypads include: XK-104 and 6805.
8. Limited energy cable must be used.
9. Non-replaceable fuse (F3). Return to manufacturer if blown. Do not solder in field.
10. Maximum for UL installations: Entry Delay, 45 sec.; Exit Delay, 60 sec.
11. For connection of VS-299 Siren Driver. Constant positive (+) unregulated output.
12. The PANIC or KEYSWITCH connected to terminals 5 & 7 is to be no more than 3 ft. from the control unit with no barriers in between.
13. Programmable trigger outputs. If used for smoke detector power reset see Detail A. See manual for programming information. Use model XL-2GTC trigger cable.

To re-load factory default values, remove all power (AC & DC). Short JP1 to JP2. With short still applied, re-apply power (AC then DC), wait 5 seconds, then remove short with power still applied.

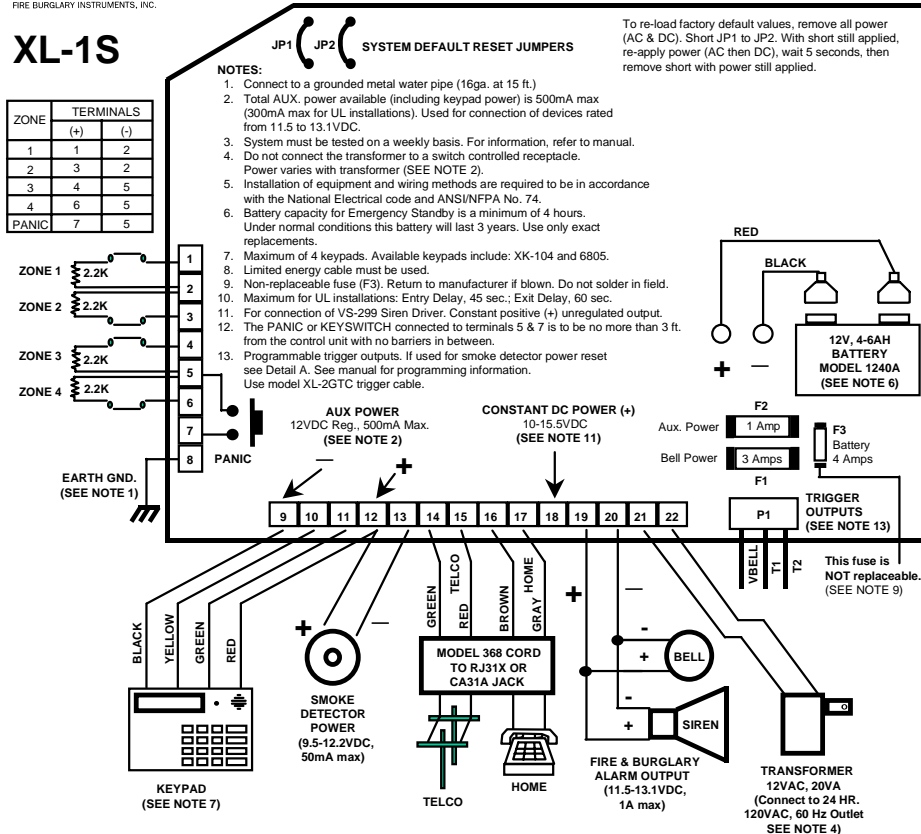

DETAIL A

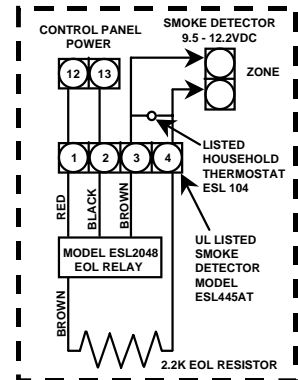

UL INSTALLATIONS REQUIRE LISTED END-OF-LINE DEVICE. USE RESISTOR FROM EOL22 KIT. LOOK FOR LISTING MARK ON ITEM.

WARNING: THIS UNIT INCLUDES AN ALARM VERIFICATION FEATURE THAT WILL RESULT IN A DELAY OF THE SYSTEM ALARM SIGNAL FROM THE INDICATED CIRCUITS. THE TOTAL DELAY (CONTROL UNIT PLUS SMOKE DETECTOR) SHALL NOT EXCEED 60 SECONDS. NO OTHER INITIATING DEVICES SHALL BE CONNECTED TO THESE CIRCUITS UNLESS APPROVED BY THE LOCAL AUTHORITY HAVING JURISDICTION.

CIRCUIT (ZONE)	CONTROL UNIT DELAY-SEC	SMOKE DETECTOR MODEL DELAY-SEC
20		

PRODUCT COVERED UNDER
US PATENT #4,791,658

WARNING: To prevent risk from electrical shock, de-energize the system control unit and disconnect the telephone lines before servicing this unit.

FCC Registration Number AE398E-69554 AL-E Ringer Equivalence 0.0B

References: Hookup and Installation Instructions N9471 and Owner's Manual N9472

LOAD NO.: 7

SYSTEM STABILIZATION MODE: Upon initial powerup of the system, all of the lights on the LED keypad(s) will go ON and then go OFF for approximately 2 min. 10 secs and/or the LCD keypad(s) will display **STAND BY!** for approximately 2 min. 10 secs. This occurs on a total powerup (if ARMED or DISARMED in its prior state) or after a system reset. If the total system power is lost then upon power restoral, the system will return to the previous arming state. The 2 min. 10 secs. interval is used to allow motion detectors (interior zones) to stabilize on power up in order to prevent false alarms. **THIS OPTION CAN BE DISABLED BY MOMENTARILY (5 second minimum) PUTTING A JUMPER BETWEEN TERMINALS 13 AND 12.**

Terminal Connections

TERMINALS	DESCRIPTION	
1(+) & 2(-)	Zone 1 (Requires 2.2K EOL resistor)	[Default = DELAY]
3(+) & 2(-)	Zone 2 (Requires 2.2K EOL resistor)	[Default = INTERIOR]
4(+) & 5(-)	Zone 3 (Requires 2.2K EOL resistor)	[Default = PERIMETER]
6(+) & 5(-)	Zone 4 (Requires 2.2K EOL resistor)	[Default = PERIMETER]

ZONE INFORMATION:

Normally closed devices may be wired in series and/or normally open devices in parallel with the 2.2k ohm end of line resistor on all zones (Refer to the wiring diagram). The standard loop response time is **280 ms** on all zones. Each zone can be programmed for **Fast Response (10 ms)** in programming (see questions #10-13). The factory default values for each zone is listed in the table above, however **any** zone can be programmed for the following types: Delay, Perimeter, Interior, Fire, 24 Hr. Alarm, or 24 Hr. Trouble. Further explanation of the zone types can be found in the System Programming section of this manual.

NOTE: Loop response is defined as the minimum time required for a fault to trip a zone.

5 & 7

PANIC CIRCUIT OR KEYSWITCH:

Normally Open PANIC circuit. This hardwired panic is a 24-hour zone that can be programmed for silent or audible operation. The panic circuit will activate with each violation, therefore a latched device is **not** recommended. A momentary device is recommended. For UL installations, the panic switch connected to these terminals is to be located no more than 3 feet from the control unit, with no intervening barriers (this is a supervision requirement only). If the keyswitch option is selected (see programming question #05, location 2), then each activation of the keyswitch will arm and disarm the system.

NOTE: EOL resistor is not required on this zone and is not supervised. This zone does not report restore codes. If a supervised zone with restore reporting ability is desired, then program one of the 4 ZONES as a 24Hr. Alarm. If used as a keyswitch, then triggers are available for either an arming or ready status indication (see programming question #07, location 4).

8

EARTH GROUND:

Connect this grounding lug to a cold water pipe utilizing #18AWG wire at a distance of no greater than 15 ft. Use a non-corrosive metal strap firmly secured to the pipe to which the lead is electrically connected and secured. If the premises pipes terminate in PVC, this terminal **must** be connected to a six- (6) foot grounding rod.

9 10 11 12

KEYPADS:

A maximum of 4 keypads, either XK-104 or 6805, may be wired to these terminals. The connections are as follows; 9 (BLACK = negative), 10 (YELLOW = data in), 11 (GREEN = data out) and 12 (RED = positive power). Each keypad draws approximately 30mA. Maximum keypad length is 500 feet using 22-gauge wire. **NOTE:** In some installations, it may be necessary to use shielded wire to prevent radio frequency interference.

- 9 (-) & 12 (+) REGULATED POWER (11.5 - 13.1VDC):**
 The total regulated output power for motion detectors and other external devices is 500mA at 11.8 - 12.5V for residential applications, or 12.0 - 12.5V for commercial applications, with less than 100 mVPP ripple. The total regulated output capacity of the XL-1S includes the power available from these terminals (9 & 12) as well as the power used by the keypads and smoke detectors. Therefore, to determine the total power available from these terminals subtract the power consumed by the keypads and smoke detectors. See Auxiliary Device Current Draw Worksheet.
- 12 (+) 13 (-) SMOKE DETECTOR POWER OR TRIGGER #1 OUTPUT:**
SMOKE DETECTOR POWER: This system will accept 9.5 - 12VDC four (4) wire smoke detectors only. Approximately 50mA of current is available at these terminals for powering all detectors and an EOL relay model ESL2048. For UL installations see wiring diagram for hookup. **NOTE:** Trigger #1 must be selected for smoke detector power (see program question #07, location 3).
 These terminals adhere to the fire verification and reset logic, which is explained in the zone types section of this manual. Manual reset of smoke detector power can be accomplished by entering a valid user code after clearing alarm memory or using the asterisk (*) key.
- 14 15 16 17 TELEPHONE LINE:**
 Connect the model 368 cord as follows; 14 (GREEN = Telco Tip), 15 (RED = Telco Ring), 16 (BROWN = Home Tip), 17 (GRAY = Home Ring). Insert the plug into an USOCRJ31X jack (or a CA31A jack for Canadian installations).
 The FCC registration number is (AE398E-69554 AL-E), and the ringer equivalence is (0.0B). The system should not be connected to party lines, or coin operated phones.



If this control panel will be used for uploading, downloading or remote command applications, the telephone line connected to the control panel **must not** be shared with a fax machine or modem. Furthermore, this device should not be connected to a phone line that has call waiting, unless the call waiting interrupt numbers are programmed into the panel dialing sequence.

- 18(+)** **CONSTANT DC POWER:**
 This terminal delivers constant unregulated 10.0-15.5VDC power for devices requiring a constant power such as VS279. It is connected to a bell fuse (F3). **NOTE:** Constant power for these devices can also be obtained by splicing the RED (+) battery lead with an in-line fuse of 3 Amps.
- 19(+)** & **20(-)** **BELL OUTPUT:**
 The total output power available for sounding devices is 1 amp at 10.5 - 15.5 VDC for residential applications, or 12.0 - 14.4 VDC for commercial installations (750 mA for UL installations). These terminals will deliver CONSTANT output on BURGLARY, AUDIBLE PANIC and BELL TEST. On a FIRE condition, a PULSED output will be generated. There are separate bell cutoff times programmable for Burglary and Fire conditions within the programming sequence. For UL Household Fire Warning System installations, the speaker must be mounted indoors for best audibility. Also, for UL installations, use only one speaker. **NOTE:** Before connecting sounding devices please consult their specifications for proper

current draw. Otherwise, the bell fuse (F3) may be blown. An option exists to supervise the bell output terminals if zone 4 is programmed as a fire zone (see program questions #10-13); refer to the following notes:

P1: VBELL (+) T1 (-) TRIGGER #1 OUTPUT:

P1-VBELL (+) & P1-T1 (-) or terminals 12 & 13 can be used for a trigger #1 output. See programming question #07, location 3 for valid trigger types. **NOTE:** In order to connect devices to the triggers use connector XL-2GTC (trigger cable). Unless otherwise specified, the trigger output is normally floating and actively sinks on activation (switched negative).

NFPA 72 REQUIREMENT: All the interconnecting pathways, (cable, wire, etc.) between the alarm system initiating device (control panel) and the signaling device (bell, speaker, siren, etc.) shall be monitored for an occurrence of an open circuit, which prevents the normal operation of the system. An occurrence of an open circuit shall be indicated by a distinctive trouble signal.

BELL SUPERVISION (Mechanical Bell) - To meet the NFPA 72 requirement **program zone 4 as a Fire Zone (program question #13, locations 1 & 2)**. The bell is then supervised for an open circuit (not a short circuit) across the bell output terminals; the keypad will indicate that a Fire Trouble condition has occurred and Fire Trouble is reported to the CS if enabled (program question #18, location 3). If the bell is already ringing, the supervision will not take effect until after bell cutoff time. See the diagram on the next page:

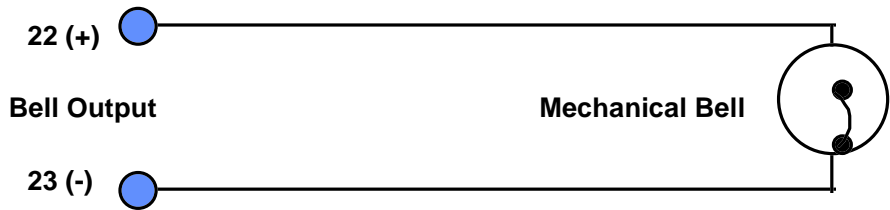

SIREN SUPERVISION (Self Contained Siren/Speaker) - To meet the NFPA 72 requirement **program zone 4 as a Fire Zone (program question #13, location 1)**. The siren is then supervised for an open circuit (not a short circuit) across the bell output terminals; the keypad will indicate that a Fire Trouble condition has occurred and Fire Trouble is reported to the CS if enabled (program question #18, location 3). If the siren is already sounding, the supervision will not take effect until after bell cutoff time. **NOTE:** Use FBII models ZR-815C, ZR-815EC or ZR-830EC. See the diagram below:

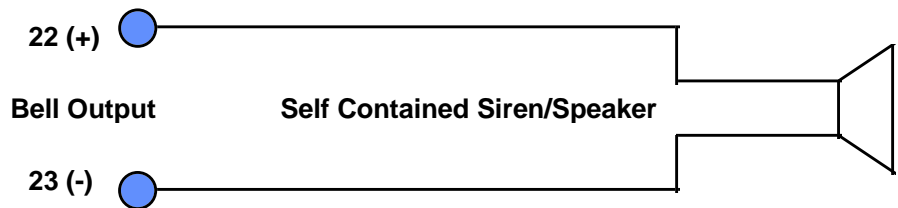

SPEAKER SUPERVISION (VS-299 Siren/Driver) - To supervise a speaker connected to the VS-299 Siren Driver **connect terminal 1 of the VS-299 to the positive terminal of any zone programmed as a 24 Hour Trouble zone (program questions #10 - 13, locations 1 & 2)**. The speaker is then supervised for an open circuit across the speaker terminals (4 & 5) of the VS-299 and a code is reported to the CS if enabled (program question #10 - 15, locations 3 & 4). Also, the connection between the bell output terminals and the VS-299 Siren Driver may be supervised by **programming zone 4 as a Fire Zone (program**

question #13, locations 1 & 2) and connecting a 10K Ohm, 1/4 W resistor across the bell output terminals to prevent a continuous supervisory condition. See the diagram below:

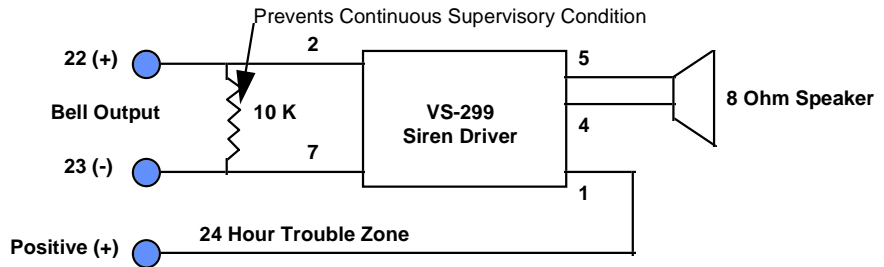

SPEAKER SUPERVISION (679S Siren/Driver) - To supervise a speaker connected to the 679S Siren Driver connect a 5.6K Ohm resistor between terminal 5 of the 679S and terminal 6 (+) of zone 4 programmed as a Fire zone (program question #13, locations 1 & 2). Replace the 2.2K Ohm EOL resistor on zone 4 with a 5.6K Ohm resistor. The speaker is then supervised for an open circuit (not a short circuit) across the speaker terminals (4 & 5) of the 679S. Also, the connection between the bell output terminals and the 679S Siren Driver will be supervised. If a supervisory occurs, the keypad will indicate that a Fire Trouble condition has occurred on zone 4 and Fire Trouble is reported to the CS if enabled (program question #18, location 3). If the siren is already sounding, the supervision will not take effect until after bell cutoff time. See the diagram on the next page:

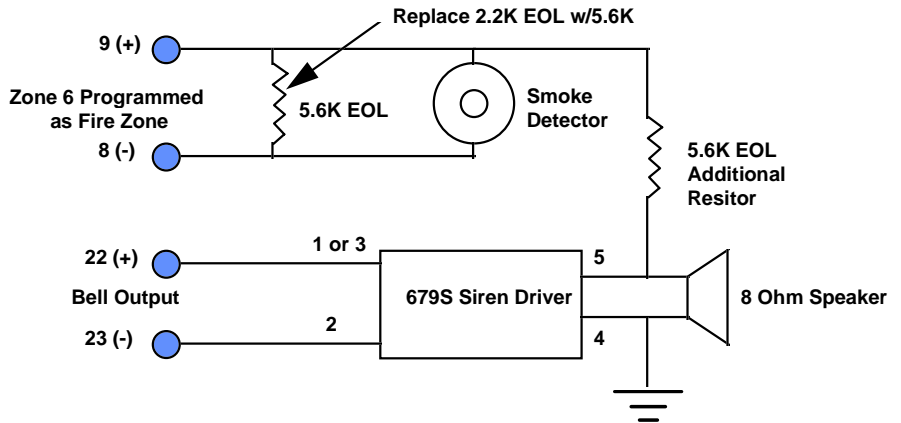

21 & 22

TRANSFORMER:

Connect the 12 VAC 20VA transformer, utilizing 18awg wire at a distance not to exceed 15 feet from the panel, to an **unswitched** 120 VAC outlet.

Do not use any other transformer since this may result in improper operation or damage to the unit.

The AC/LOW BAT LED on the keypad will remain ON, while AC power is present. If an AC loss occurs the AC/LOW BAT LED will turn off immediately. If AC remains OFF for 15 minutes, the system will pulse

the keypad buzzer and transmit to the central station, if programmed. THE KEYPAD BUZZER CAN BE SILENCED by entry of any valid user code. When AC restores the AC/LOW BAT LED will light immediately, and a restore code will be reported, if programmed.

BACKUP BATTERY: The RED (+) and BLACK (-) flying leads must be connected to a 12 VDC 4-6AH GELL CELL, to serve as backup power in the event of AC loss.

A battery test occurs approximately every 4.5 minutes. Low battery condition occurs at nominal 11VDC. The keypad AC/LOW BAT LED and buzzer will PULSE SLOWLY when a low battery condition is detected. The system reports this condition to the CS if programmed. Battery restoral will occur WITHIN 4.5 minutes, at the NEXT battery test. THE BUZZER MAY BE SILENCED by entry of any valid user code.

GROUND START: Ground start capability can be added to the system through addition of the FBII Model 117 module. Consult the 117 Installation Instructions for hookup information. With this device some systems can obtain dialtone where it is not available. At the moment telephone line seizure occurs, the Telco Tip is momentary connected to earth ground to access dial tone.

NOTE: The 117 module has not been tested for use in UL installations.

P1: VBELL, T1 & T2 TRIGGER OUTPUTS (1 & 2):

The control panel contains two programmable trigger outputs. Trigger #1 terminals are P1-VBELL (+) & P1-T1 (-) and for Trigger #2 P1-VBELL (+) & P1-T2 (-). See programming question #07, location 4 for valid trigger types. BY DEFAULT TRIGGER #1 IS ENABLED FOR SMOKE DETECTOR POWER, WHICH CAN ALSO BE OBTAINED FROM TERMINALS 12(+) & 13(-). TRIGGER #2 CANNOT BE SELECTED FOR SMOKE POWER. **NOTE:** In order to connect devices to the triggers use connector XL-2GTC (trigger cable). Unless otherwise specified, the trigger output is normally floating and actively sinks on activation. Connect to terminal 12 (+) to obtain a POSITIVE reference point. For UL installations, the trigger outputs shall be connected to devices rated to operate over the range from 10.1 - 14.0 VDC at 50 mA.

Auxiliary Device Current Draw Worksheet

DEVICE	CURRENT DRAW FOR EACH	NUMBER OF UNITS	TOTAL CURRENT FOR EACH
XK-104 Keypad	30mA *		
6805 Keypad	60mA *		
PIR	**		
Smoke Detector	**		
Glass Break Detector	**		
	**		
	**		
TOTAL CURRENT FOR ALL DEVICES =			
(500mA max.)			

NOTES: * Only applies if device is powered from control terminals 12 (+) & 13 (-).

** If using devices such as PIRs, smoke detectors, etc., refer to the specifications for that particular device's current draw. If the total current draw exceeds 500mA, then use an additional power supply.

Wiring Information for Keypads & Other Devices

Keypads & Other Devices

If single or multiple devices are connected to a single 4-wire or 2-wire run ("daisy chained") to the control terminals, determine the current drawn by the unit(s) connected to the single wire run, then refer to the Wiring Run Table below to determine the maximum wire length that can be safely used for each wire size.

In some cases, the total current drawn may result in a value not shown in the table. For example, if you plan to use #22 gauge wire and the total current drawn is 400 mA (a value between 300 mA and 500 mA), the maximum wire length you should use is approximately 65 ft. (a length between 50 and 80 ft.). Other maximum wire lengths for values of current not shown in the table can be calculated in a similar manner.

Maximum wire lengths for a device that is "homerun" to the control can also be determined from the table, based on the current draw of that device alone.

Wiring Run Table For Devices Drawing Power From Terminals 12 (+) & 13 (-)

WIRE SIZE	TOTAL CURRENT DRAWN BY ALL UNITS ON A SINGLE WIRE RUN			
	50 mA or less	100 mA	300 mA	500 mA
#22	500 ft. (152 m.)	250 ft. (76 m.)	80 ft. (24 m.)	50 ft. (15 m.)
#20	750 ft. (228.6 m.)	380 ft. (116 m.)	130 ft. (39.6 m.)	80 ft. (24 m.)
#18	1300 ft. (396 m.)	650 ft. (198 m.)	220 ft. (67 m.)	130 ft. (39.6 m.)
#16	2000 ft. (609.6 m.)	1000 ft. (305 m.)	330 ft. (100.5 m.)	200 ft. (70 m.)

Examples:

1. What is the maximum distance for one XK-104 keypad drawing 30 mA using # 20 gauge wire?

Using the table above, the keypad can be placed no greater than 750 ft. away from the panel.

2. What is the maximum distance for three 6805 keypads drawing 180 mA (60 mA each) using # 20 gauge wire connected in a single wire run?

Using the table above, the farthest keypad can be placed no greater than 292 ft. away from the panel.

3. What is the maximum distance for 5 smoke detectors drawing 0.25 mA (5 μ A each) using # 22 gauge wire connected in a single wire run?

Using the table above, the farthest smoke detector can be placed no greater than 500 ft. away from the panel.

PC Board Mounting

Mounting the PC Board

Before mounting the printed circuit board, be certain that the appropriate metal knockouts have been removed. **DO NOT ATTEMPT TO REMOVE THE KNOCKOUTS AFTER THE CIRCUIT BOARD HAS BEEN INSTALLED.**

1. Hang the three mounting clips on the raised cabinet tabs. Observe proper clip orientation to avoid damage to the clip when mounting screws are tightened and to avoid problems with insertion and removal of the PC board.
2. Insert the top of the circuit board into the slots at the top of the cabinet. Make sure that the board rests in the slots as indicated in the diagram shown below.
3. Swing the base of the board onto the mounting clips.
4. Place the washer provided over the wire jumpers located within the middle of the PC board. Secure the PC board to the middle mounting clip of the enclosure through the washer using the screw provided.
5. Secure the remaining sides of the PC board to the enclosure using the screws provided.

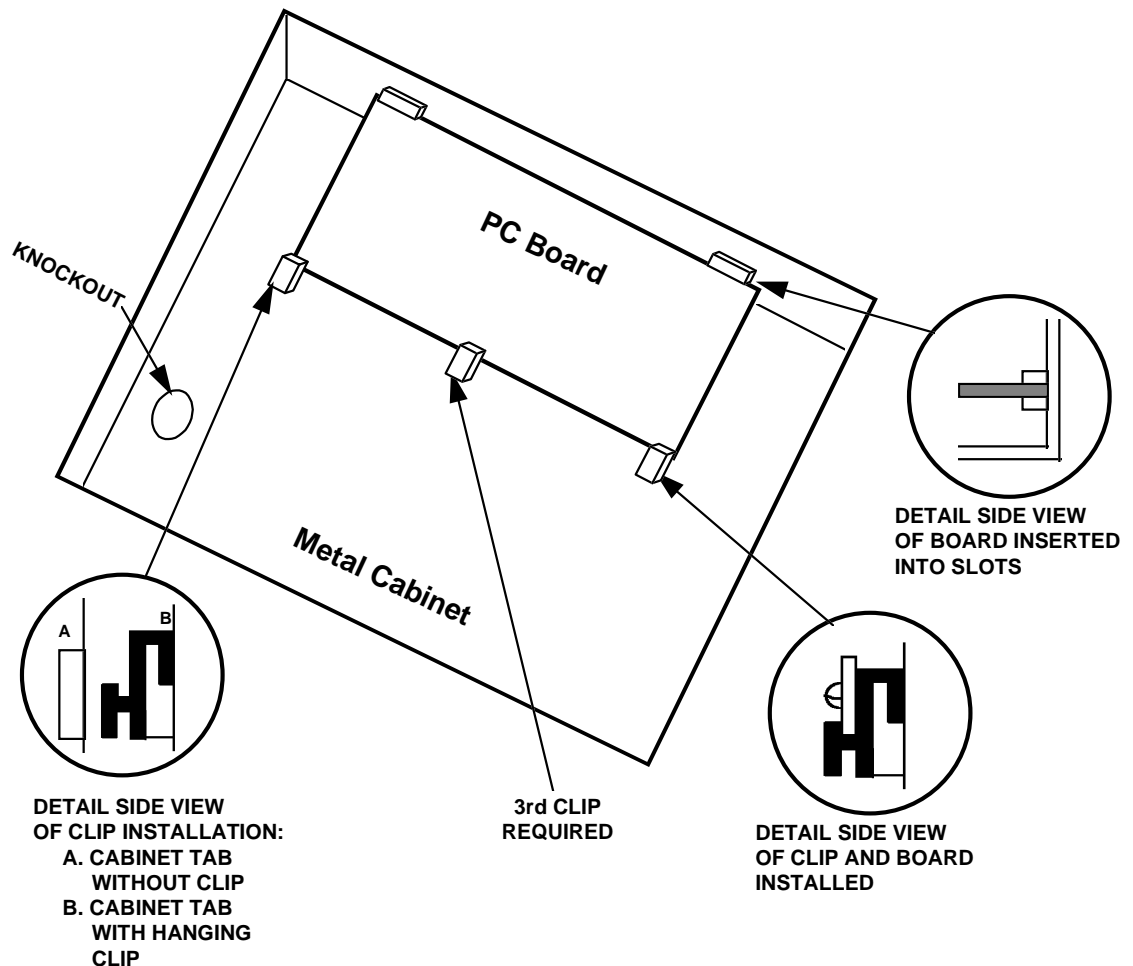

NOTE: The front face of the enclosure can be completely removed from the enclosure to gain unrestricted access to the control panel during installation. The front of the enclosure can be removed as follows:

1. Open the enclosure to its fully extended position (approx. 90 degrees)
2. Lift the control panel door and remove the door from the enclosure.

Keypad Mounting

XK-104 Keypad

The XK-104 Keypad may be surface mounted in the following ways:

- A. Directly to a control panel having a keypad cutout on the front of its enclosure.
- B. Directly to a single or double gang electrical junction box.
- C. Directly to a wall or other surface.

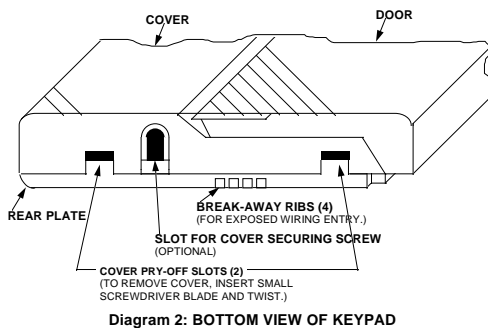

Diagram 2: BOTTOM VIEW OF KEYPAD

1. Remove the keypad cover assembly from the rear mounting plate. Insert a small screwdriver blade in the COVER PRY-OFF SLOTS at the lower edge of the keypad (see Diagram 2) and twist to pry off the cover assembly.
2. Mount the rear plate (see Diagram 3).

NOTE: The plate is correctly oriented when its part number, molded into the plastic, is upright.

A. Mounting Directly To Control Panel Enclosure:

If the control panel has a keypad cutout on the front face of its enclosure, remove the cutout and mount the plate to the enclosure's face via HOLES "A" (see diagram 3) and the four screws and nuts provided.

NOTE: The VT-200 attack-proof enclosure does not contain a keypad cutout.

B. Mounting Directly To An Electrical Junction Box:

The plate can be mounted directly to a single or double gang electrical junction box. Use the screw holes provided and HOLES "B" for a single gang box or HOLES "A" for a double gang box.

C. Mounting Directly To A Wall Or Other Surface:

Provide a wiring hole in the mounting surface. Position the plate's WIRING OPENING over the hole and mounting plate, using HOLES "A" and/or "B" in conjunction with appropriate mounting hardware (not provided) for the type of surface.

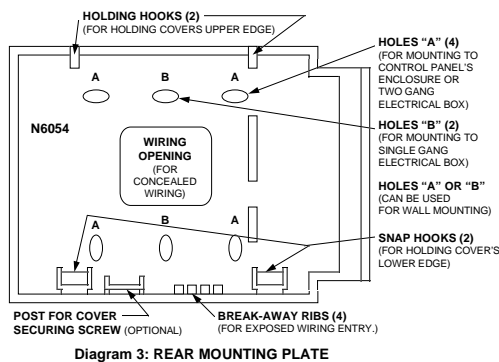

Diagram 3: REAR MOUNTING PLATE

3. Complete the keypad wiring as required for the control with which the keypad is to be used.

4. Replace the keypad cover assembly on the rear plate. Starting at the upper edge of the plate, engage the plate's two HOLDING HOOKS (see diagram 3) into the recesses provided for them inside the upper edge of the cover assembly and snap the lower edge of the cover assembly and snap the lower edge of the cover onto the two SNAP HOOKS at the lower edge of the plate.

NOTE: (Optional) If desired, cover and plate can be further secured together by inserting a screw (provided) into the SLOT at the keypad's lower edge.

NOTE: When surface mounting the keypad, and using screws with heads larger than the screws provided with the unit, place electrical tape over the screws to prevent them from interfering with the keypad operation. In the future the back plate of the keypad will provide additional countersinking for screws with larger heads.

Mounting 6805 Keypad

Keypads can be surface mounted or flush mounted as described below. **NOTE:** After mounting the 6805 LCD Keypad at eye level, you can adjust the display intensity level to suit the user by adjusting the intensity control located behind the keypad door.

SURFACE MOUNTING

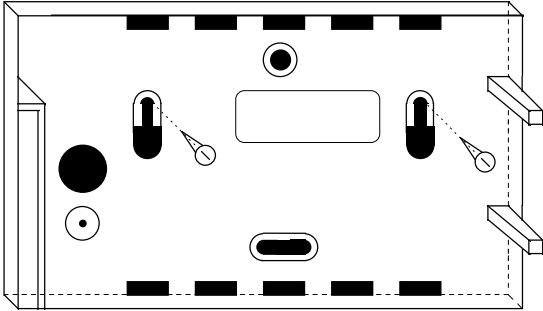

1. Select a mounting location and place the rear plate of the keypad on the wall. Mark the location of the cutout for the keypad wiring cable.
2. Create a keypad opening. Connect the keypad wiring to the control panel w/ 4-wire connector.
3. Place the keypad wiring through the cutout and secure the back plate to the wall (see diagram).
4. Connect the keypad wiring connector to the keypad and place the keypad on the mounting plate attached to the wall.
5. Secure the keypad to the rear mounting plate by attaching the 5/8-inch screw provided in the lower hole, located behind the keypad door.

RECESSED MOUNTING

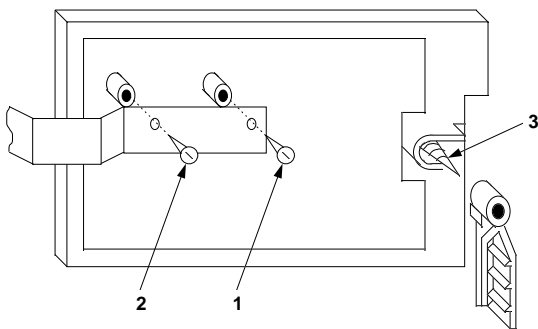
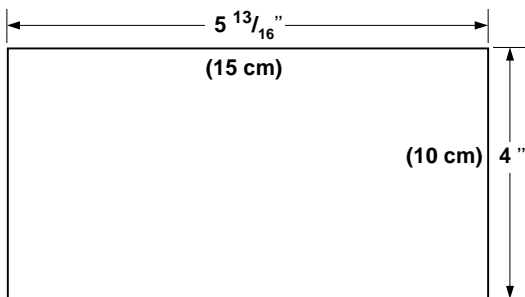

- 1- Select a mounting location. For recessed mounting this must be between two studs. The rear mounting plate is not used for recessed installations.
- 2- Create an opening in the wall exactly 4 inches high by 5 13/16 inches wide.
- 3- Turn over the keypad and remove the Phillips head screw (item 1 on diagram) in the upper left hand side of the keypad printed circuit board. **NOTE:** This screw is located immediately to the left of the keypad connector.
- 4- Attach the black metal mounting strap to the rear of the keypad as follows (see diagram);
 - Face the pointed end of the mounting strap facing the keypad front. This will be used to latch onto the inside of the wall.
 - Place the small white plastic spacer underneath the mounting strap. Secure the mounting strap using the 5/8-inch Phillips head screw (supplied) and the plastic spacer to location 1.
 - Secure the other end of the strap (location 2 on diagram) to the white plastic opening using the Phillips head screw removed in step 2.
- 5- Connect the white plastic tab into the round opening immediately behind the keypad door. Place the longer Phillips head screw (included) through the opening inside the keypad door and begin to tighten the screw. Tighten the screw and leave the tab in a down position.
- 6- Run the keypad wiring to the control panel and attach the wiring to the keypad.
- 7- Place the keypad into the wall opening with the side containing the black metal strap first until it grabs the inside of the wall.
- 8- After inserting the side of the keypad with the metal strap, insert the other side into the opening until the entire keypad is firmly in the wall.
- 9- Tighten the screw inserted in step 5.

Keypad Layout

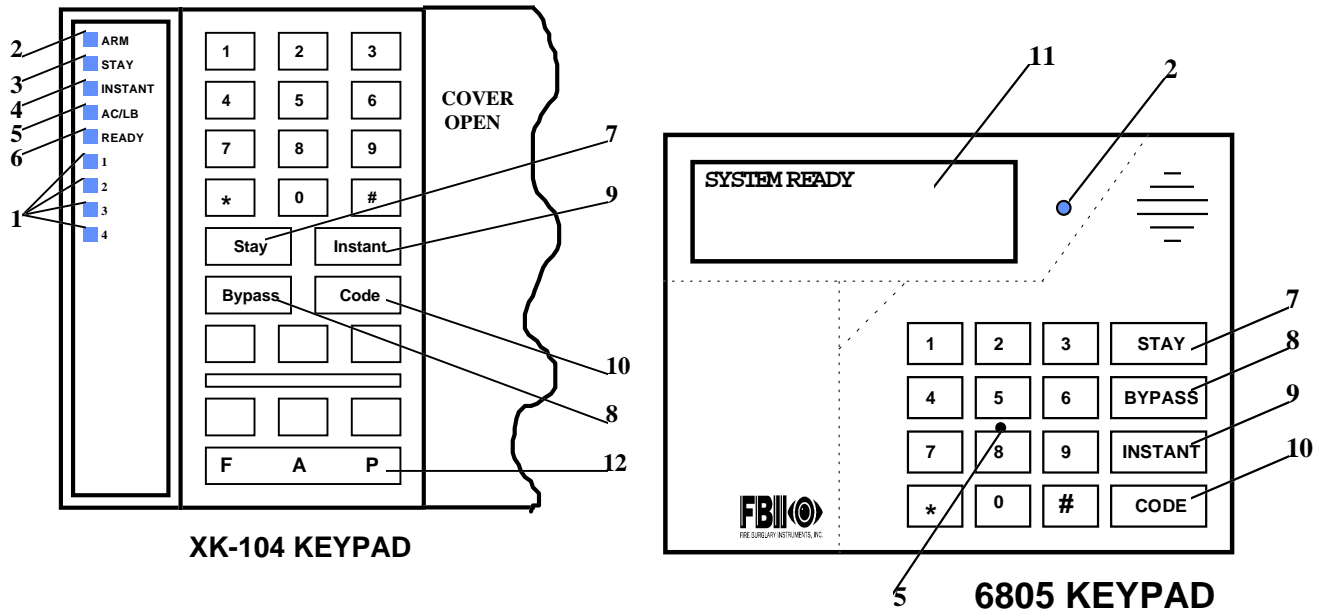

1. ZONE STATUS LEDs

These LEDs display the current zone status including alarms, bypasses, troubles and faults. Each condition will cause these LEDs to operate differently as follows:

ALARMS Fast Blink (approx. 150 ms ON - 150 ms OFF).

TROUBLES Slow Pulse (approx. 600 ms ON - 600 ms OFF).

BYPASSES Wink (100 ms ON - 900 ms OFF). Zone bypasses are displayed as a very slow wink of the zone LED light.

FAULTED ZONES Solid ON. Faulted zones are the lowest priority indication.

Faulted burglary zones are displayed with the LED solidly ON while the system is disarmed.

NORMAL OFF



Upon Entry to disarm the system the keypad sounder will annunciate to warn the user to disarm it. In addition, the respective zone LED(s) will be ON to indicate zones which are violated (ex: entry door and motion detector).

2. ARM/DISARM LED

This LED indicates whether the system is currently armed (ON) or disarmed (OFF).

Fast Blink Alarm Mode

Slow Wink Fail to Communicate with Central Station

3. STAY LED

This LED displays whether the system has been armed in the STAY mode or the STAY/INSTANT mode. If the INSTANT LED is ON and the STAY LED is ON, then the system is in the STAY/INSTANT mode. If the INSTANT LED is OFF and the STAY LED is ON, then the system is in the STAY mode only. In either mode the STAY LED indicates the following:

ON	Interior zones are bypassed
OFF	Interior zones are normal

4. INSTANT LED

This LED displays whether the system has been armed in the INSTANT or STAY/INSTANT mode, meaning that the system is currently armed, all delay zones are instant and all interior zones are bypassed. If the STAY LED is OFF and the INSTANT LED is ON, then the system is in the INSTANT mode. If the STAY LED is ON and the INSTANT LED is ON, then the system is in the STAY/INSTANT mode.

ON	Delay zones are currently instant
OFF	Delay zones are normal

5. AC/LOW BATTERY LED

This indicator light displays the current power status of the panel as follows;

ON	AC is present
OFF	No AC, running on battery backup
Slow Blink	Low battery condition detected

6. READY LED

This LED displays whether the system is ready for arming. The READY light is common to all BURGLARY ZONES with the following indications:

ON	System ready to be armed
OFF	System not ready to be armed
Slow Blink	Indicates Installer programming mode
Fast Blink	Alarm Memory Mode

7. STAY BUTTON

The STAY button enables arming the system, excluding zones programmed as interior zones. This will provide exterior protection of the location while allowing full access throughout the interior.

8. BYPASS BUTTON

The BYPASS button is used to temporarily exclude protection to a specific zone.

9. INSTANT BUTTON

If enabled, the INSTANT button enables arming the system in the INSTANT mode and with the STAY button it enables arming the system in the STAY/INSTANT mode. **NOTE:** INSTANT mode is enabled in question #05, location 4.

10. CODE BUTTON

The CODE button is used to enter the installer programming mode and entry of user codes.

11. LCD DISPLAY

The LCD display shows the current status in a two line by twelve character format.

12. KEYPAD AUXILIARY KEYS (XK-104 KEYPAD ONLY)

Pressing the two keys (top & bottom) labeled F (Fire), A (Auxiliary) and P (Panic) at the same time initiates a CS transmission, if programmed, of PANIC, AUXILIARY (Emergency) or FIRE, annunciates the keypad sounder and turns on the bell output. If not programmed to transmit, these keys can only result in a local warning as follows (see question #05, location 1):

Keypad Sounder - Steady for PANIC, Pulsing for FIRE and AUXILIARY
Bell Output - Steady for PANIC, Pulsing for FIRE



See the Keypad Emergency Conditions section for alternate auxiliary keys.

Keypad Sounder

The keypad sounder annunciates differently to indicate the following conditions:

CHIRP - Keypad sounds a short chirp to confirm each keystroke.

STEADY - The keypad will make a steady sound during entry time, and/or during burglary alarm.

CHIME - steady 1 second tone (SYSTEM DISARMED ONLY).

ACKNOWLEDGE - Upon successful entry of a certain commands the system will sound for approximately half a second.

PULSING - A pulsing sound (approximately half a second ON then OFF) indicates a trouble condition such as AC loss, Low Battery, or Fire Zone.

NEGATIVE ACKNOWLEDGMENT - Upon entry of an illegal command the keypad will sound four short beeps. For example, if attempting to define a new user and the master user is not entered, four short beeps will be made indicating that the command was unsuccessful.

SOUNDER RINGBACK - Several short beeps to indicate successful communication to the Central Station. This occurs for all signals, excluding ambush and silent zones.

FAST PULSING SOUNDER- Sound generated during entry time period AFTER an alarm condition has occurred and the system reached bell cutoff. A pulsing sounder will follow the bell output on Fire conditions. Trouble conditions also generate a pulsing sounder and may be silenced through entry of a valid user code.



The keypad is non-operational if none of the LEDs are lit and the keypad does not beep when keys are pressed. This is an indication that service is required. Consult the troubleshooting section of this manual.

System Operations

Power Up/System Reset

SYSTEM STABILIZATION MODE: Upon initial powerup of the system, all of the lights on the LED keypad(s) will go ON and then go OFF for approximately 2 min. 10 secs and/or the LCD keypad(s) will display **STAND BY!** for approximately 2 min. 10 secs. This occurs on a total powerup (if ARMED or DISARMED in its prior state) or after a system reset. If the total system power is lost then upon power restoral, the system will return to the previous arming state. The 2 min. 10 secs. interval is used to allow motion detectors (interior zones) to stabilize on power up in order to prevent false alarms. THIS OPTION CAN BE DISABLED BY MOMENTARILY (5 second minimum) PUTTING A JUMPER BETWEEN TERMINALS 13 AND 12.

Arming the System

The system can be armed only if all burglary zones are good (not faulted). On LED based keypads this requires that the READY LED be on.

On LCD keypads the following message will appear:

SYSTEM: READY

TO ARM: Enter any programmed four-digit user. **NOTE:** The factory default for user #1 is 1234.

The ARMED LED will light and the user may exit through an exit/entry zone for the time period programmed as the exit delay. The system can be armed without the backup battery being connected, however the AC/LB light will flash.

LCD Based keypads will display:

ON: AWAY

Stay Arming

TO ARM: Press the STAY BUTTON followed by a four-digit user code.

The ARMED and STAY LEDs will light on LED based keypads.

LCD based keypads will display:

ON: STAY

The system is armed at this time with all programmed interior zones excluded.

Instant Arming

TO ARM: Press the INSTANT BUTTON followed by a four-digit user code.

The ARMED and INSTANT LEDs will light on LED based keypads.

LCD based keypads will display:

ON: INSTANT

The system is armed at this time with all programmed delay zones instant; this eliminates the exit/entry time delays. **NOTE:** INSTANT arming is ALWAYS enabled (see question #05, location 4).

Stay/Instant Arming

TO ARM: Press the INSTANT then STAY buttons and a four-digit user code.

The INSTANT STAY mode will arm the system with the characteristics of both the INSTANT and STAY modes. The system will be armed with the interior zones bypassed and the delay zones instant.

LED keypads will have the ARMED, STAY and INSTANT LEDs lit.

LCD keypads will display:

ON: STAY INSTANT

Disarming

TO DISARM: Press any valid four- (4) digit user code and ARMED LED will extinguish.

If an alarm condition exists or had occurred while the system was armed, the zone LED(s) and the READY LED will be blinking rapidly. This ALARM MEMORY condition can be cleared by entering a valid user code or using the asterisk (*) key.

Reset

After an alarm occurs, the system enters alarm memory mode either after bell time-out or by a user entering a valid user code silencing the bell and keypad buzzer. **Alarm memory and communications failure can be cleared by entering a valid user code.** If a fire alarm occurs, then clearing alarm memory resets the smoke detectors for approximately 8 seconds.

In addition, you can use the * key to act as a reset in addition to using a valid user code for clearing Fire Alarms Only. THIS OPTION IS ALWAYS ENABLED.

Bypass

Bypassing is performed to temporarily exclude zones that are faulty or not ready from activating the system.

Press the BYPASS button followed by any valid four- (4) digit user code, followed a number 1-4, which represents the respective zone to be bypassed.

EXAMPLE: BYPASS ZONE 2 (Assume user code of 1234)
BYPASS 1234 2

Subsequent bypasses can be made by pressing the BYPASS button followed by another zone number within a ten second period. After this ten-second period it will be necessary to enter the entire command including the user code.

After a successful bypass the keypad sounder will sound the acknowledge beep, and the respective zone LED will WINK SLOWLY.

The bypass rules are:

- FIRE zones cannot be bypassed
- 24-hour zones can be bypassed, however they CANNOT be unbypassed if they are violated.
- Zones can only be bypassed while the system is disarmed, at which time visual indication will be displayed.
- Bypass signals are transmitted to the Central Station UPON ARMING if a bypass code has been programmed.



Zones that are bypassed are not protected when the system is armed.

Auto Unbypass

All burglary zones which are bypassed can be automatically unbypassed upon system disarm, assuming no other zone(s) had been in alarm. 24-hour zones, which have been bypassed, will be unbypassed only if they are normal.

THE AUTO-UNBYPASS FEATURE IS ALWAYS ENABLED.

Manual Unbypass

This function removes an existing bypass from a currently bypassed zone. **The procedure is the same as bypass.**

User Code Programming

User codes can be entered or modified directly through the keypad. The system contains up to six user codes (4 digits each) with the following applications:

USER NUMBER	APPLICATION	DEFAULT CODE
1	Master User (see note 1)	1234
2	Normal User	NULL
3	Normal User	NULL
4	Normal User	NULL
5	Normal User	NULL
6	Ambush (see note 2)	NULL

NOTES: Only the master user (user number 1) can program or modify other users. Therefore, do not misplace this code. Should you misplace you must perform a user code default. Refer to the Installer Modes section.

1. User Number 1 - programs all user codes (1-6); cannot be deleted.
2. User Number 6 - can be programmed as an ambush code if there is an ambush CS transmission code programmed into question #16, locations 1 & 2. In this mode, entry of the user #6 code will ARM or DISARM the system and transmit the ambush code to the Central Station. Furthermore if opening/closing by user reporting is programmed, user number 6 will be reported along with the ambush code. If no CS code is defined in question #16, then user number 6 will be a normal user code.

To Add Or Change Users: [CODE] [USER] [USER #] [USER ID]

Where:

[CODE] Press CODE button
 [USER] Enter Master User ID code (user #1)
 [USER #] Press Desired user to be programmed (1-6)
 [USER ID] Enter Four-digit user code. Valid digits are 0-9

Example: Define user #3 with an ID of 7493. (Assume master user code is 1234).

CODE 1234 3 7493

An acknowledgment sound (steady tone) verifies a successful user code programming. A negative acknowledgment sound (4 short tones) indicates unsuccessful programming.

If additional user programming is necessary, repeat the procedure listed above. If a dialing format is programmed which transmits opening/closing by user ID, each user will report the respective user number.



User code programming can be ONLY performed while the system is DISARMED.

User Deletion

User codes (2 - 6) can be deleted directly through the keypad. Once deleted their values will be null.

To Delete Users: [CODE] [USER] [USER #] [*]

Where:

[CODE] Press CODE button

[USER] Enter Master User ID code (user #1)

[USER #] Press the desired user number being deleted (2-6).

NOTE: User # 1 cannot be deleted, but it can be changed.

[*] Press the asterisk (*) button

Keypad Emergency Conditions

The system has the ability to transmit keypad emergency conditions as follows:

CONDITION	KEYSTROKES	ENABLED IN	AUDIBLE OR SILENT
PANIC	# & * (at the same time)	Question #05, location 1	Question #04, location 4

For example, the 24 HR. keypad panic can be initiated by pressing the # and * keys at the same time. The panic condition can be silent (no bell output) or audible based on the programming option. **NOTE:** The default value for panic is audible.

Audible panic can be RESET BY ENTERING ANY VALID USER CODE.

Installer Modes

TO ENTER INSTALLER MODE: [CODE][*][INSTALLER][X]

Where:

[CODE]	Press the CODE button
[*]	Press the asterisk (*) button
[INSTALLER]	Enter the 4 digit installer code (default = 2468)
[X]	Press the single digit indicating the installer mode as follows:
	1 Installer Keypad Programming
	Press 1 & 3 (at the same time) SYSTEM DEFAULT
	Press 7 & 9 (at the same time) USER CODE DEFAULT

Installer Mode 1 (Installer Keypad Programming)

Enters the installer into keypad programming mode. Refer to the Keypad Programming Section of this Manual. **NOTE:** There exists an option in the EZ-Mate Downloader Software to inhibit keypad programming. If selected, then a negative acknowledgment (4 short beeps) will be heard after attempting to enter this mode. The software has another option (Default Lockout) to inhibit another installer from defaulting the panel and entering keypad programming. This prevents hostile account takeovers.

Installer Mode 1 (System Default)

Any of the system keypads (LED & LCD) can initiate a system default of the system by **pressing the “1” and “3” keys at the same time**, while in the programming mode. The system will then default (revert to factory program values) and go through the reset sequence and THE SYSTEM WILL UNDERGO THE WARMUP TIME SEQUENCE. A system default can also be generated by removing power (AC & DC), shorting JP1 & JP2, reapplying power (with JP1 & JP2 still intact) waiting 8 seconds, and then removing short with power still applied. **NOTE:** A programming option can be selected through the EZ-Mate Downloader Software known as **Default Lockout**. If selected, then a system default reset will change all of the programmable options with the exception of the CSID (a code used by the software to identify the panel during remote connections) and the installer code. This prevents hostile account takeovers.

Installer Mode 1 (User Code Default)

The user codes can be reset to factory default values (User Code 1 = 1234) by pressing the **“7” and “9” keys at the same time**, while in the programming mode. The user codes will default and the system will go through the reset sequence and THE SYSTEM WILL UNDERGO THE WARMUP TIME SEQUENCE.

Installer Mode 2 (System Log View)

The system retains the past 2 alarm memory conditions; this can contain from 1 – 6 alarms per arming cycle or up to 12 alarms for two arming cycles. LED keypads will display alarms as fast blinking cone lights along with a fast blinking ready (RDY) light. In both keypad types (LCD and LED), the display will show the events starting from the oldest event. Pressing of the “#” key will advance the log to the most recent alarm in memory. To exit from the system log view mode press the “*” key. **NOTE:** as the log is advanced, the LCD keypad will scroll through all zones that were in alarm for the event. The system log cannot be cleared by the keypad. It can only be cleared by the Downloader Software. On LCD keypads

the following log cannot be cleared by the keypad. It can only be cleared by the Downloader Software. On LCD keypads the following appears:

ALARM MEM: ZN1 FRONT DOOR

TO EXIT THE SYSTEM LOG VIEW MODE: Press the asterisk key (*). However, if the asterisk key (*) does not exit, enter a valid user code.

Installer Mode 3 (Unattended Download)

The Unattended Download function allows the installation of the control panel and then have the control panel dial the telephone number of CS downloading computer so that the control panel can be downloaded without having the operator present. Basically, the CS downloading computer telephone number will be programmed into the callback number (question 03) and an identification number (same as the account number in the downloader software) will be programmed into the secondary telephone (question 02). **NOTE:** These are temporary values since they will be reprogrammed after downloading.

Unattended Download requires the following sequence:

1. The PC operator must select UNATTENDED DOWNLOAD in the Downloader Software Main Menu.
2. Enter Unattended Download mode: **[CODE][*] [INSTALLER][3]**.
3. The system will now enter keypad programming at question 01. Enter the telephone number of the central station downloading computer. Enter [#] after each digit; for example: [1] [#] [2] [#] [3] [#]. You can enter up to 12 digits. This phone number should be the same as the CS callback number (question 03 from Keypad Programming if the panel is programmed for callback).
4. Go to programming question 02 by entering the sequence [*] [0] [2]. Enter the desired account number, following each digit with [#]. This will be used by the CS downloading computer to determine the proper account information to download to this subscriber. The account number must be 6 digits in length and it is the downloaders account designator not the account number that will be communicated to the receiver. For ID's less than 6 digits long you must enter leading 0's to make the number 6 digits long. Example: for ID 345 enter [0] [#] [0] [#] [0] [#] [3] [#] [4] [#] [5] [#].
5. Press the "STAY" key to exit Programming mode. The control panel will now dial the downloading computer telephone number entered into the callback number. (If you have not already selected the Unattended Communications option from the main menu of the downloading computer, select it prior to continuing.) Upon connection with the computer the customer account number programmed in step 3 will be obtained and the system will perform the desired download operation. **NOTE:** The CS downloading computer must be waiting in the Unattended Communications option and preprogrammed with the account information in order for the Unattended Download to be functional.

Installer Mode 4 (On-Line Download)

In this mode, the installer can initiate a remote communications session with the CS Downloading computer at the control panel location. Typically, a remote communications session is initiated by the CS. On-line downloading allows the installer to call the office (from the same telephone line as the panel), discuss the action required and allow the CS operator to complete the request while on-line. No additional telephone call is needed. On-line connection can be made as follows:

1. After completing the installation, attach a handset to the telco terminals (tip and ring) or uses the standard home telephone to dial the CS downloading modem telephone line. Connection is made with a person at the CS downloading computer and the account to be

downloaded is verbally identified. The downloading computer operator selects “On-line Remote Operations” from the Device menu.

2. Enter the on-line download sequence: [CODE] [*] [INSTALLER] [4] or use the end-user command of [#] [9], if enabled. This will cause the control panel to behave as if it received a request for a remote communications session, and to look for the standard panel to CS protocol.
3. Once the standard connection is made, the necessary remote communications sessions can take place (Upload, Download, and Remote commands).
4. Hang up the telephone or remove headset from the line to prevent interference that may affect upload/download data. The downloader software will automatically terminate the connection after remote communications end.

System Programming

General

The system can be programmed in any one of the following methods:

- Directly through keypad (XK-104 or 6805)
- EZ-MATE PC DOWNLOADER model 7700 remotely

NOTE: The EZ-Mate downloader has not been tested for UL applications.

This manual describes system programming via the keypad. The other programming devices include documentation describing their programming procedures.

Keypad programming is accomplished by understanding and completing the PROGRAMMING SHEET located in the back of this manual.

There are 20 total programming questions numbered 00-19.

Within each question there are several locations labeled L1, L2, etc. for data entry.

The system is shipped from the factory with SPECIFIC DEFAULT VALUES that were selected for a typical installation. If the default values are suitable for your installation then programming can be simplified. The default values are listed with each programming question and in the SYSTEM DEFAULT section of this manual.

Programming Questions

This portion of the manual defines the programming questions along with the values expected for each question. **BEFORE USING THE PROGRAMMING SHEET, FILL THE SYSTEM PLANNING WORKSHEETS AT THE END OF THIS MANUAL. Then, Complete the Programming sheet and then enter the data through the keypad as explained in the section titled Data Entry Through the Keypad. DO NOT ATTEMPT TO ENTER DATA BEFORE COMPLETELY FILLING OUT PROGRAM SHEET.**

QUESTION 01

PRIMARY TELEPHONE NUMBER

DEFAULT = 234AAAAAAAAA

Enter the telephone number (including area code and/or dialing prefix IF NECESSARY) of the primary central station receiver in L1 - L12. Enter the valid digits from the table below.

Digit	FUNCTION	COMMENTS
0-9	0-9	
A	Signifies end of the phone number	Enter after last digit of phone number
B	Asterisk (*)	Enter whenever the asterisk is used
C	3 Second pause	Provides delay to wait for dial tone
D	Pound (#)	Enter whenever the pound is used
E	*70C (Touch-tone) * 1170C (Rotary)	Enter to disable Call Waiting
F	800	Enter whenever the "800" prefix is needed

REPORTING ROUTE:

The system will report all signals to the primary receiver phone number. The panel will alternate between the primary and secondary receivers (if the second phone number is programmed) for a maximum of 8 attempts each until the signal has been acknowledged.

QUESTION 02

SECONDARY TELEPHONE NUMBER

DEFAULT = AAAAAAAAAAAAAA

Enter the telephone number (including area code and/or dialing prefix IF NECESSARY) of the secondary central station receiver in L1 - L12.

Enter the valid digits from the table in question 01. The secondary telephone number will be used if the panel is unable to reach the Central Station via the primary number. This is known as BACKUP reporting. If the SPLIT REPORTING feature is programmed, then OPENING and CLOSING signals will be directed to the secondary CS number only, while all other conditions will be reported to the primary number.

If neither split nor backup reporting is necessary then this question may be left as factory defaulted and all conditions will be routed to the Primary Telephone number only.

QUESTION 03

CALLBACK TELEPHONE NUMBER

DEFAULT = AAAAAAAAAAAAAA

Enter the telephone number (including area code and/or dialing prefix if necessary) for this control panel to reach the callback location. The callback number is the optional location of the EZ-Mate Downloader where the control panel will call during a remote communications (upload/download etc) session. During remote communications the programming device and the control panel will first confirm the CS security code. If valid, communications can begin. If a callback number is defined, the control panel will the hang up and dial the callback number. Enter the valid digits from the table in question 01. **NOTE:** For no callback capability enter AAAAAAAAAAAAAA.

QUESTION 04

DIALER OPTIONS

DEFAULT = 1601

There are 4 locations (L1-L4) within this question which define various dialer and system options as follows:

Question 04, L1

Dialer Formats

DEFAULT = 1

Enter the digit for the desired dialer format from the table below in location L1. **NOTE:** The checkmark highlights which options are selected.

Digit	DIALING FORMAT		CS REPORTING FORMAT
	PULSE	TOUCH-TONE	
0	✓		STANDARD OR 4X2
1		✓	STANDARD OR 4X2
8	DIALER DISABLE		LOCAL ALARM ONLY

NOTE: See Question #04, location 3 to select specific CS Reporting Format Message Length and specific Dialing Pulse Type.



If Local Alarm is desired, then no other options need to be disabled (Telephone #, CS Codes).

Question 04, L2

CS Receiver Type

Default = 6

Enter the digit for the desired receiver type from the table below in location L2. **NOTE:** The checkmark highlights which options are selected.

Digit	FORMAT PULSE SPEED			HANDSHAKE FREQUENCY			TYPICAL CS RECEIVER
	10 PPS	20 PPS	40 PPS	1400 HZ	2300 HZ	PARITY	
0	✓			✓			FBI, ADEMCO, SILENT KNIGHT
1	✓			✓		✓	FBI
2	✓				✓		FBI
3	✓				✓	✓	FBI

Digit	FORMAT PULSE SPEED			HANDSHAKE FREQUENCY			TYPICAL CS RECEIVER
	10 PPS	20 PPS	40 PPS	1400 HZ	2300 HZ	PARITY	
4		✓		✓			FBI, SILENT KNIGHT, ADCOR, ADEMCO
5		✓		✓		✓	FBI, RADIONICS
6		✓			✓		FBI, FRANKLIN, SESCOA, DCI, VARITECH
7		✓			✓	✓	FBI, RADIONIC
8			✓	✓			FBI
9			✓	✓		✓	FBI
A			✓		✓		FBI
B			✓		✓	✓	FBI, RADIONICS

NOTE: UL compatible receivers: FBI CP220 (all formats), ADEMCO 685, Silent Knight 8520, 9000, RADIONICS.

Question 04, L3

CS Format Message Length, System Swinger Shutdown & Pulse Type Default = 0

Enter the digit for the desired message length from the table below in location L3. **NOTE:** The checkmark highlights which options are selected.

Digit,	CS REPORTING FORMAT MESSAGE LENGTH				SYSTEM SWINGER SHUTDOWN	DIALING PULSE TYPE	
	3X1	3X2	4X1	4X2		U.S.	EUROPEAN
0	✓					✓	
1	✓						✓
2			✓			✓	
3			✓				✓
4		✓				✓	
5		✓					✓
6				✓		✓	
7				✓			✓
8	✓				✓	✓	
9	✓				✓		✓
A			✓		✓	✓	
B			✓		✓		✓
C		✓			✓	✓	
D		✓			✓		✓
E				✓	✓	✓	
F				✓	✓		✓

NOTE: Please consult your Central Station manager to determine the formats and message lengths which are accepted by the receiver. European dialing format has not been tested by UL.

DIALING PULSE TYPE - Specifies how this control will perform pulse dialing (U.S. Pulse or European Pulse) when CS transmissions are enabled. **NOTE:** European Pulse has not been tested for UL installations.



For more information on CS Reporting Formats refer to Appendix A at the back of this manual.

Question 04, L4

K.P. Panic, CS Split Reporting, Cancel Bell Ringback & System Bell Test Default = 1

Enter the digit for the desired system options from the table below in location L4. **NOTE:** The checkmark highlights which options are selected.

Digit	KEYPAD PANIC		CS SPLIT REPORTING	CANCEL CODE BELL RING BACK		SYSTEM BELL TEST
	AUDIBLE	SILENT		SILENT	AUDIBLE	
0		✓		✓		
1	✓			✓		
2		✓	✓	✓		
3	✓		✓	✓		
4		✓			✓	
5	✓				✓	
6		✓	✓		✓	
7	✓		✓		✓	
8		✓		✓		✓
9	✓			✓		✓
A		✓	✓	✓		✓
B	✓		✓	✓		✓
C		✓			✓	✓
D	✓				✓	✓
E		✓	✓		✓	✓
F	✓		✓		✓	✓

KEYPAD SILENT/AUDIBLE PANIC - Determines whether the keypad panic condition (* & # from the keypad) will activate the bell and the keypad buzzer. In either case a signal will be transmitted to the Central Station if a panic code has been programmed. **NOTE:** The keypad panic condition can be activated through question #05, location 1.

SPLIT REPORTING - The split reporting option will direct all opening and closing signals to the secondary receiver telephone number. All other conditions (alarms, troubles, restores etc.) will adhere to the reporting route described in question 01. If split reporting is selected then the secondary receiver telephone number **MUST** be programmed.

CANCEL CODE BELL RING BACK - If AUDIBLE, the bell will RING BACK for 1 second when the cancel code is sent, provided that some other transmission would not cancel this event (ex: silent panic). If SILENT, the bell will not RING BACK.

BELL TEST - If this option is selected the bell will be activated for one second upon successful arming. This option is required for UL Commercial Burglary applications.

QUESTION 05

KEYPAD CONDITIONS

DEFAULT = 127C

This question contains four locations (L1-L4) for various keypad definable options.

Question 05, L1

Keypad Panic, System Stay Mode Dialer Delay & Bell Instant

Default = 1

Enter the digit for the desired system options from the table below in location L1. **NOTE:** The checkmark highlights which options are selected.

Digit	KEYPAD PANIC	STAY MODE DIALER DELAY	STAY MODE BELL INSTANT	KEYPAD AUXILIARY	
				AUDIBLE	SILENT
0					✓
1	✓				✓
2		✓			✓
3	✓	✓			✓
4			✓		✓
5	✓		✓		✓
6		✓	✓		✓
7	✓	✓	✓		✓
8				✓	
9	✓			✓	
A		✓		✓	
B	✓	✓		✓	

Digit	KEYPAD PANIC	STAY MODE DIALER DELAY	STAY MODE BELL INSTANT	KEYPAD AUXILIARY	
				AUDIBLE	SILENT
C			✓	✓	
D	✓		✓	✓	
E		✓	✓	✓	
F	✓	✓	✓	✓	

NOTE: Keypad Fire and Keypad Auxiliary are always enabled. Auxiliary Audible/Silent selection refers to keypad sounder only (not the bell). Keypad Fire is always Audible. Keypad Panic is Audible or Silent based on quest. #04, location 4.

STAY MODE DIALER DELAY - If selected this will give the system an additional delay as follows: When the system is armed in the STAY mode, any control zone alarm (delay, interior, and perimeter) will cause the **dialer to be delayed by 40 seconds**. A delay zone will first follow the entry delay and then the 40 second delay. Also, during the 40-second dialer delay the keypad sounder will be activated and the bell depending on whether it is selected (see STAY MODE BELL INSTANT). When the system is not armed in the STAY mode, the 40-second delay is disabled. If not selected, the 40-second delay during the STAY mode will be disabled.

STAY MODE BELL INSTANT - This is selected in conjunction with the STAY MODE DIALER DELAY option. If selected, the bell will sound instantly during the 40-second delay. If not, the bell will also follow a 40-second delay.

Question 05, L2

Misc Options

Default = 2

Enter the digit from the table below in location L2. **NOTE:** The checkmark highlights which options are selected.

Digit	ZONE 7 INPUT			AC LINE FREQUENCY		QUICK COMMANDS ENABLED
	PANIC		KEYSWITCH	50 HZ	60 HZ	
	AUDIBLE	SILENT				
0		✓			✓	
1			✓		✓	
2	✓				✓	
4		✓			✓	✓
5			✓		✓	✓
6	✓				✓	✓
8		✓		✓		
9			✓	✓		
A	✓			✓		
C		✓		✓		✓
D			✓	✓		✓
E	✓			✓		✓

ZONE 7 INPUT: PANIC or KEYSWITCH - This option determines whether connections 5 & 7 on the control panel will be used as a panic input (audible or silent) or a keyswitch input. **NOTE:** If keyswitch is selected and the transmission code sends a user code, then user code #7 will be transmitted.

AC LINE FREQUENCY - This selects which AC input frequency (60 HZ or 50 HZ) is present for the AC based system Clock.

Question 05, L3

CS Test Time Interval

Default = 7

If CS Test Report is enabled, this option determines the test time interval. **NOTE:** The checkmark highlights which options are selected.

Digit	CS TEST TIME INTERVAL						EUROPEAN RING DETECT
	1 HOUR	24 HOUR	WEEKLY	27 DAYS	60 DAYS	90 DAYS	
0		✓					
1			✓				
2				✓			
3					✓		
4						✓	
6	✓						
7	NONE (CS TEST DISABLED)						
8		✓					✓
9			✓				✓
A				✓			✓
B					✓		✓
C						✓	✓
E	✓						✓
F	NONE (CS TEST DISABLED)						✓

CS TEST - Select from 1 Hour or 24 Hour. This is reset after a successful CS Test report only. **NOTE:** To initiate the CS test sequence some time in advance from the time the installation is completed within the same day refer to question #14. CS test reporting code is entered in question #17, locations 3 & 4.

EUROPEAN RING DETECT - Use this option if a European Telephone System is used only. This option changes the ring detection frequency used for automatic answer mode for remote (Downloading) purposes only according to the programmed ring count (see programming question #07, location 2). If selected, the ring detection frequency range is 10 - 90Hz. If not selected, the frequency range is 16 - 90Hz.

Question 05, L4

Rest Foll Loop, CS Test Ringback & Instant Arming

Default = C

Enter the digit from the table below in location L4. **NOTE:** The checkmark highlights which options are selected.

Digit	RESTORE AFTER BELL	RESTORE FOLLOWS LOOP	USER ON-LINE	CS TEST KEYPAD RING BACK		INSTANT ARMING
				SILENT	AUDIBLE	
0	✓				✓	
1		✓			✓	✓
2	✓		✓		✓	✓
3		✓	✓		✓	✓
4	✓			✓		✓
5		✓		✓		✓
6			✓	✓		✓
7		✓	✓	✓		✓
8	✓				✓	
9		✓			✓	
A	✓		✓		✓	
B		✓	✓		✓	
C	✓			✓		
D		✓		✓		
E	✓		✓	✓		
F		✓	✓	✓		

RESTORE AFTER BELL - Restores will be transmitted after the loop has returned to normal after bell cutoff, or upon system disarming regardless of the loop state.

CS TEST RINGBACK SILENT - After a CS Test Report has reached the Central Station, the sounder ringback will not be heard from the keypad, indicating a successful communication to the CS.

INSTANT ARMING ENABLED - This option permits the INSTANT arming option (INSTANT or STAY/INSTANT mode) to be used.

QUESTION 06
SYSTEM TIMEOUTS

DEFAULT = 665F

There are 4 locations (L1-L4) within this question which define various system timing options as follows:

Question 06, L1
Entry Delay 1

Default = 6

Enter the desired entry delay time. If zones 1 & 2 are delay zones, they follow entry delay 2. Refer to Entry Times below for valid choices. For UL applications the maximum entrance delay shall not exceed 45 seconds for household applications or 15 seconds for commercial burglary applications.

Digit	ENTRY TIMEOUTS
0	1 SECOND
1	5 SECONDS
2	10 SECONDS
3	15 SECONDS
4	20 SECONDS
5	25 SECONDS
6	30 SECONDS
7	35 SECONDS
8	40 SECONDS
9	45 SECONDS
A	50 SECONDS
B	55 SECONDS
C	1 MINUTE
D	1 MINUTE 5 SECONDS
E	1 MINUTE 10 SECONDS
F	3 MINUTES

Question 06, L2
Exit Delay

Default = 6

Enter the desired exit time. **NOTE:** For UL applications the maximum exit delay shall not exceed 60 seconds.

Digit	EXIT TIMEOUTS
0	1 SECOND
1	10 SECONDS
2	20 SECONDS
3	30 SECONDS
4	40 SECONDS
5	50 SECONDS
6	1 MINUTE
7	1 MINUTE 10 SECONDS
8	1 MINUTE 20 SECONDS
9	1 MINUTE 30 SECONDS
A	1 MINUTE 40 SECONDS
B	1 MINUTE 50 SECONDS
C	2 MINUTES
D	2 MINUTES 10 SECONDS
E	2 MINUTES 20 SECONDS
F	3 MINUTES

Question 06, L3
Burglary Bell Cutoff

Default = 5

Enter the desired bell cutoff time on alarm conditions for burglary and panic in 3-minute intervals. The valid range of input is 1 - F, with F indicating an infinite burg bell cutoff. Example 3 = 9 minutes. For UL installations in commercial applications the minimum bell cutoff shall be 15 minutes, or 6 minutes for household burglary applications.

Digit	BURGLARY & FIRE BELL TIMEOUTS
1	3 MINUTES
2	6 MINUTES
3	9 MINUTES
4	12 MINUTES
5	15 MINUTES
6	18 MINUTES
7	21 MINUTES
8	24 MINUTES
9	27 MINUTES
A	30 MINUTES
B	33 MINUTES
C	36 MINUTES
D	39 MINUTES
E	42 MINUTES
F	INFINITE

Question 06, L4
Fire Bell Cutoff

Default = F

Enter the desired bell cutoff time for fire conditions in three-minute intervals. The valid range of input is 1 - F, with F indicating an infinite fire bell cutoff. Example 3 = 9 minutes. For UL installations the minimum fire bell cutoff time shall be 6 minutes.

QUESTION 07
MISCELLANEOUS SYSTEM OPTIONS

DEFAULT = 2705

There are 4 locations (L1-L4) within this question which define various system timing options as follows:

Question 07, L1
Entry Delay 2

Default = 2

Enter the desired entry delay time. Refer to Entry Times in question #6, L1 for valid choices. If zones 3 & 4 are delay zones, they follow entry delay 2. For UL applications, the maximum entrance delay shall not exceed 45 seconds for household applications or 15 seconds for commercial burglary applications.

Question 07, L2
Ring Count & System Dialer Delay

Default = 7

Enter the digit from the table below in location L2. **NOTE:** The checkmark highlights which options are selected.

Digit	REMOTE COMMUNICATIONS RING COUNT	SYSTEM DIALER DELAY	TRANSMIT ZONE RESTORE
0	NONE (REMOTE COMM. DISABLED)		
1	4 RINGS		
2	8 RINGS		
3	12 RINGS		
4	NONE (REMOTE COMM. DISABLED)		✓
5	4 RINGS		✓
6	8 RINGS		✓
7	12 RINGS		✓
8	NONE (REMOTE COMM. DISABLED)	✓	
9	4 RINGS	✓	
A	8 RINGS	✓	
B	12 RINGS	✓	
C	NONE (REMOTE COMM. DISABLED)	✓	✓
D	4 RINGS	✓	✓
E	8 RINGS	✓	✓
F	12 RINGS	✓	✓

REMOTE COMMUNICATIONS RING COUNT - is the number of rings for the control panel to pickup for a remote communications session. This should be selected to a value that does not interfere with normal operation of the panel location. The default value is 12 rings. **NOTE:** A value of 0 rings means that remote programming will be disabled. **Select from the choices above.**

SYSTEM DIALER DELAY - If selected, all controlled zones will have a 15 second dialer delay, allowing the user to ABORT the CS transmission. If not selected, any alarm condition will result in an immediate transmission that cannot be aborted. **NOTE:** For UL installations this option must not be selected.

TRANSMIT ZONE RESTORE - If enabled, this option enables the transmission of zone restores along with system restores (AC loss, Low Bat, etc.). If not enabled, the ONLY restores transmitted will be the system restores (see question #18, location 2).

Question 07, L3

Trigger #1 Output

Default = 0

The smoke power terminals (12 & 13) or P1, T1 can be used as trigger #1 output. If a fire zone requiring fire verification is used in the system, the trigger should be programmed as "0". If the fire device does not need a power reset, or no fire zone type is selected, the trigger can be programmed as shown in the Trigger Types Chart. **NOTE:** Smoke Power Output can only be enabled for trigger #1.

Question 07, L4

Trigger #2 Output

Default = 5

A secondary Trigger output can be obtained from P1, T2. The following Trigger Type Chart shows the valid entries.

Digit	TRIGGER TYPE DEFINITION	DESCRIPTION OF OPERATION
0	Smoke Power Output (Trigger #1 Only)	Used in Fire Verification to reset smoke power
1	Fire Bell ON	Follows Fire Bell Timer
2	Burglary Bell ON	Follows Burglary Bell Timer
3	Telephone Line Seizure	Follows Line Seizure Relay when dialer is activated
4	Ready	Follows Ready LED; used for keyswitch
5	Armed	Follows Armed LED; used for keyswitch
6	Exit Time	ON during exit time
7	Entry Time	ON during entry time
8	Fire Only Latch	ON w/Fire Bell, OFF w/code
9	Burglary Only Latch	ON w/Burglary Bell, OFF w/code
A	Strobe	ON steady w/Burglary Bell, Pulse w/Fire Bell
B	Panic Alarm	Zone 5 (Hardwired Panic): ON w/alarm, OFF w/code
C	Shock Asterisk Reset	Asterisk "*" activates for 2-6 seconds
D	Shock Code Reset	Normally sinking current: floats when armed for 2-6 sec.
E	Duress	Pulses for 2-6 seconds following entry of Duress code



Unless otherwise specified, the trigger output is normally floating and actively sinks on activation.

QUESTION 08

ACCOUNT NUMBER 1

DEFAULT = 1234

Enter the three- (3) or four- (4) digit subscriber account number for Central Station phone number 1 in locations L1-L4. If a three- (3) digit number is used then enter an A in location L4. Valid entries are 0-9, and B-F. The value A is interpreted as the null value for account numbers.

QUESTION 09

ACCOUNT NUMBER 2

DEFAULT = AAAA

Enter the three- (3) or four- (4) digit subscriber account number for Central Station phone number 2 in locations L1-L4. If a three- (3) digit number is used then enter an A in location L4. Valid entries are 0-9, and B-F. The value A is interpreted as the null value for account numbers. If the second phone number is not used this question can be left as factory defaulted.

THIS ACCOUNT NUMBER **MUST** BE ENTERED IF YOU HAVE PROGRAMMED A SECOND RECEIVER PHONE NUMBER FOR BACKUP OR SPLIT REPORTING.

Zone Programming

Questions 10-13 represent all the options related to programmable zones 1-4. Each question contains four (4) locations L1-L4. The first two locations (L1 & L2) define the zone type and options. The second two locations (L3 & L4) define the alarm code transmitted to the Central Station for that zone.

Zone Types

Zones 1-4 can be programmed for any one of the following zone types:

L1L2 Digits	BURGLARY (CONTROLLED) ZONES						
	ZONE TYPE			ZONE OPTIONS			
	INSTANT (PERIMETER)	DELAY (EXIT/ENTRY)	INTERIOR FOLLOWER	CHIME	DAY	BYPASS IN STAY	FAST ZONE
10	✓			NONE (INSTANT ZONE W/O OPTIONS)			
11	✓					✓	
12	✓				✓		
13	✓				✓	✓	
14	✓			✓			
15	✓			✓		✓	
18	✓						✓
19	✓					✓	✓
1A	✓				✓		✓
1B	✓				✓	✓	✓
1C	✓			✓			✓
1D	✓			✓		✓	✓
20		✓		NONE (DELAY ZONE W/O OPTIONS)			
21		✓				✓	
24		✓		✓			
25		✓		✓		✓	
40			✓	NONE (INTERIOR ZONE W/O OPTIONS)			
41			✓			✓	
44			✓	✓			
45			✓	✓		✓	
48			✓				✓
49			✓			✓	✓
4C			✓	✓			✓
4D			✓			✓	✓

Burglary (Controlled) Zones

DELAY - This is the industry standard exit/entry zone. When the system is armed exit time begins. After exit expires, any subsequent violation of this zone will begin entry time. If the system is not disarmed within the programmed entry time an alarm will occur. The keypad sounder will annunciate steadily during entry time, unless there had been an alarm condition, at which time it will pulse. Delay zones will activate instantly when the system is armed using the STAY/INSTANT mode if enabled. Delay zones employ the Exit Error Warning feature described in the note below.

INTERIOR - All interior zones have exit delay time upon system arming. Furthermore, all interior zones will have entry delay time if a delay zone is violated first. If this zone is violated first however, it will generate an immediate alarm. Interior zones are bypassed if Bypass In Stay is selected. Interior zones employ the Exit Error Warning feature described in the note below.

PERIMETER - This zone type (sometimes known as INSTANT) will generate an alarm when violated while the system is armed.

EXIT ERROR WARNING - At the end of exit time a 1-second window is started. If any delay or interior zones are violated after arming within this window (exit time expires and entry time starts) the burglary bell and keypad sounder will be turned on forcing the user to enter their code preventing a false alarm transmission. This helps avoid the common false alarms that take place after arming the system.

Burglary Zone Options

RESTORE - This option is selected for all burglary zones by enabling the restore report code (question 18, location 2) and enabling transmit zone restores in question #07, location 2. The programmed restore code will be reported upon bell cutoff. The restore code will also be reported if the system is disarmed during an alarm. **NOTE:** Restore is not selectable by zone.

BYPASS IN STAY - This option allows zones to be bypassed when the system is armed in the STAY mode.

CHIME - If this option is selected the keypad sounder will annunciate for 1 second when this zone is violated in the disarmed mode.

DIALER DELAY - If this option is selected (quest. #07, location 2), then the system (burglary zones only) will allow a 15 second delay before dialing, allowing the end user to ABORT the transmission. If this option is not selected, any alarm condition will result in an immediate transmission that cannot be aborted.

UL

For UL installations dialer delay may not be used.

DAY FEATURE - If a zone with this option is violated while the system is DISARMED, the keypad sounder and zone LED will pulse for as long as the violation remains and the panel will dial 15 seconds after the violation of the zone. In addition, the SYSTEM TROUBLE CODE will be transmitted to the central station. THE SOUNDER CAN BE SILENCED through entry operation of any valid user code. While the system is armed, a DAY zone will act as an alarm when violated.

FAST ZONE - If enabled, the zone response will be **10 msec**. If not selected, it will be 280 msec.

24 Hour Zones

Zones 1-4 can be programmed for any one of the following 24-hour zone types:

L1L2 Digits	24 HOUR ZONES				
	ZONE TYPE			ZONE OPTIONS	
	24 HR. ALARM	FIRE	24 HR. TROUBLE	AUDIBLE	SILENT
81	✓			✓	
82			✓	✓	
84		✓		ALWAYS AUDIBLE	
89	✓				✓
8A			✓		✓

FIRE - FIRE zones on the system contain Fire Verification Logic. Upon detection of the first violation, smoke detector power will be reset for a period of 8 seconds. After this time period, power is restored. For a period of 5 seconds the fire zone will not be scanned allowing the smoke detectors to settle. Future violations within a two-minute period will result in a PULSING BELL OUTPUT, RAPID PULSING ZONE LED, and IMMEDIATE transmission to the CS. Fire signals cannot be aborted.

Entry of any valid user code will silence the sounder, bell and reset smoke detector power. If the system detects that the fire zone is still violated within 2 minutes of power reset, the zone LED will pulse slowly to indicate a fire trouble. Thereafter, smoke detector power will be reset every 4 minutes automatically in an attempt to clear the fire zone.

In the event the fire zone experiences an open, the system indicates fire trouble by pulsing the keypad zone LED and sounder slowly. The system trouble code (followed by the zone code) will be reported to the CS.

The keypad sounder can be SILENCED through entry of ANY VALID USER CODE. **NOTE: FIRE ZONES cannot be bypassed. ZONE 4 CAN BE PROGRAMMED AS A FIRE ZONE FOR BELL SUPERVISION.**

24 HR. ALARM - This zone type is always active, independent of the system arming status. Programming options include audible (STEADY BELL) or silent (NO BELL or keypad indications). Upon violation the zone LEDs will pulse rapidly (audible zones only) and an immediate CS transmission will occur which cannot be aborted.

24 Hour Alarm zones can be bypassed, however they cannot be unbypassed if a violation exists on the zone terminals.

24 HR. TROUBLE - This zone type is always active, independent of the system arming status. Programming options include audible (PULSING KEYPAD SOUNDER) or silent. Upon violation the zone LED will pulse slowly. Trouble condition must exist for 15 seconds before a transmission will occur. The keypad display and sounder will clear upon zone restoral.

24 Hour Trouble zones can be bypassed, however they cannot be unbypassed if a violation exists on the zone terminals.



24-hour trouble is not to be used for fire and burglary detection zones. 24-Hour silent alarm zones are not to be used for perimeter protection. THE SOUNDER MAY BE SILENCED THROUGH ENTRY OF ANY VALID USER CODE.

WARNING: Fire Zones CANNOT BE BYPASSED. 24 Hour zones CAN BE BYPASSED, however, they CANNOT BE UNBYPASSED if a violation exists on their terminals.

Zone Alarm Codes

As previously specified locations L3 and L4 of the zone questions represent the alarm code that will be reported to the central station.



Zones will transmit to the Central Station unless these digits are defined as AA for any individual zone, or the local dialer option is selected for all zones in question #04, location 1.

Based on the dialer format selected enter the alarm code as follows:

STANDARD FORMAT (3X1 or 4X1): Enter the desired single digit alarm code in location L3 for the specific zone. The value placed in L4 will not be used.

4x2: Enter the desired first digit of the alarm code in location L3 and the second digit in L4 for the specific zone. Both digits will be used for all transmissions.



For more information on CS Reporting Formats refer to Appendix A at the back of this manual.

QUESTIONS 10 - 13 ZONES 1 - 4

There are 4 locations (L1-L4) within each of these questions which define the operation of the zones. Enter a 2-digit number in locations L1 and L2 from the zone chart for the desired type for this zone. Enter the desired alarm code in locations L3 and L4 for this zone relative to the dialer format selected.

QUESTION 10

ZONE 1 TYPE & CS CODE

DEFAULT = 2031

Question 10, L1 & L2 - Zone 1 Type

Default = 20

Question 10, L3 & L4 - CS Code for Zone 1

Default = 31

Zone 1 = Delay (Entry/Exit) w/CS reporting code = 31

QUESTION 11

ZONE 2 TYPE & CS CODE

DEFAULT = 4132

Question 11, L1 & L2 - Zone 2 Type

Default = 41

Question 11, L3 & L4 - CS Code for Zone 2

Default = 32

Zone 2 = Interior Follower w/CS reporting code = 32

QUESTION 12

ZONE 3 TYPE & CS CODE

DEFAULT = 1033

Question 12, L1 & L2 - Zone 3 Type

Default = 10

Question 12, L3 & L4 - CS Code for Zone 3

Default = 33

Zone 3 = Instant (Perimeter) w/CS reporting code = 33

QUESTION 13

ZONE 4 TYPE & CS CODE

DEFAULT = 1034

Question 13, L1 & L2 - Zone 4 Type

Default = 10

Question 13, L3 & L4 - CS Code for Zone 4

Default = 34

Zone 4 = Instant (Perimeter) w/CS reporting code = 34



If zones 3 & 4 are programmed as DELAY zones, they follow ENTRY DELAY #2. If zone 4 is programmed as a FIRE zone, Bell Supervision is enabled. See Bell Output Terminal connections for description.

QUESTION 14

CS TEST OFFSET

DEFAULT = 083B

There are 4 locations L1-L4 in this question.

Question 14, L1 & L2 - CS Test Offset Hours

Default = 08

Question 14, L3 & L4 - CS Test Offset Minutes

Default = 3B

This option allows the installer to initiate the automatic CS Test sequence some time in advance from the time the installation is completed within the same day. For example, if the installation is completed at 6:00 PM and the test is desired at 1:00 PM, then program an

offset of 7 hours. Enter hours and minutes in hexadecimal. The valid range for hours is 01 - 18 (24 hours) and the valid range for minutes is 01 - 3C (60 minutes).

QUESTION 15

CS CODES for AMBUSH and AC LOSS

DEFAULT = AAAA

There are 4 locations L1-L4 in this question as follows:

Question 15, L1 & L2 - Ambush Code

Default = AA

If an ambush code is defined, then user number 6 is the ambush code. The same rules apply here regarding dialer format. If transmission is not desired, then program AA in locations L1 & L2. **NOTE:** AMBUSH transmissions are immediate and not abortable.

Question 15, L3 & L4 - AC Loss Code

Default = AA

The same rules apply here regarding dialer format. If transmission is not desired, then program AA in locations L3 & L4. **NOTE:** AC LOSS is reported 15 minutes after detection.

QUESTION 16

CS CODES for PANIC and LOW BATTERY

DEFAULT = 22AA

There are 4 locations L1-L4 in this question.

Question 16, L1 & L2 - Panic Code

Default = 22

The same rules for programming regarding dialer format apply here. If transmissions are not desired, then program AA in locations L1 & L2. **NOTE:** PANIC transmissions are immediate and not abortable.

Question 16, L3 & L4 - Low Battery Code

Default = AA

The same rules for programming regarding dialer format apply here. If transmissions are not desired, then program AA in locations L3 & L4. LOW BATTERY transmissions will be reported 4 minutes after detection. LOW BATTERY RESTORE CODE will be reported WITHIN 4 minutes after detection of GOOD BATTERY condition.

QUESTION 17

CS CODES for OPEN/CLOSE and CS TEST

DEFAULT = AAAA

There are 4 locations L1-L4 in this question.

Question 17, L1 - Opening Code

Default = A

Question 17, L2 - Closing Code

Default = A

L1 is the single digit OPENING CODE. L2 is the single digit CLOSING CODE. Entry of AA into these two locations means that openings and closings are not desired. If a dialer format other than standard is programmed then the second digit transmitted will be the user number.

Question 17, L3 & L4 - CS Test Code

Default = AA

L3 - L4 is the CS Test CODE. Entry of AA means that CS Test is not enabled. If CS Test code is selected then ANY valid transmission will reset the CS Test timer.

QUESTION 18

CS CODES for BYPASS, RESTORE, TROUBLE and CANCEL

DEFAULT = AAF8

There are four (4) locations L1 - L4 in this question.

Question 18, L1 - Bypass Code

Default = A

L1 is the single digit system BYPASS CODE that will be reported to the central station if a zone is bypassed, UPON ARMING. Entry of an A means that bypasses are not transmitted. If a two digit dialing format has been selected then the Bypass code will be followed by the programmed second digit of the zones code.

Question 18, L2 - Restore Code

Default = A

L2 is the single digit system RESTORE CODE reported to the central station. This is the system restore code for AC loss, Low Bat, etc. Restores will be ALSO be reported for all

burglary or 24 hour zones by enabling this code (entry of any code except A) and enabling transmit zone restores in question #07, location 2. Entry of an A means that restores of any type are not transmitted. If a two digit dialer format has been programmed, the restore code will be followed by the programmed second digit of the zones code. **NOTE:** Restore is not selectable by zone.

Question 18, L3 - Trouble Code**Default = F**

L3 is the single digit system TROUBLE CODE reported to the central station. This code will be reported on DAY TROUBLE and any FIRE TROUBLE. If a two digit format has been programmed then this code will be followed by the second digit of the respective zones code.

Question 18, L4 - Cancel Code**Default = 8**

L4 is the single digit system CANCEL CODE reported to the central station. This code will be sent if after a violation of a controlled zone, a user code is entered. If the zone is still violated, entry of a user code will transmit the cancel code. If the zone is programmed for restoral, then the restore code will be transmitted when the loop status has returned to normal. An entry of A in this field indicates that cancel codes are not transmitted. In formats requiring 2 digits, the user number functions as the second digit. **NOTE:** An option exists to make the Cancel Code Bell Ringback either AUDIBLE or SILENT (see question #04, location 4).

QUESTION 19**CS CODES for KEYPAD FIRE and KEYPAD AUXILIARY****DEFAULT = AAAA**

There are 4 locations L1-L4 in this question.

Question 19, L1 & L2 - Keypad Fire Code**Default = AA**

L1 - L2 is the alarm code that will be transmitted upon activation of the keypad fire condition. This code can vary from any of the zones that are programmed as fire.

Question 19, L3 & L4 - Keypad Auxiliary Code**Default = AA**

L3 - L4 is the code transmitted to the CS for keypad aux. condition.

QUESTION 00**INSTALLER CODE****DEFAULT = 2468**

There are 4 locations L1 - L4 in this question. Enter any 4 digit (0-9 installer code desired). This code is used to ENTER the system programming mode via the keypad.

Typically each installing company would use a unique installer code in order to prevent unauthorized people from gaining access to their panels.

Data Entry via LED & LCD Keypads

This section describes the physical keystrokes necessary to perform keypad programming and how to interpret the data displayed on the LED based keypads (XK-104) and on the LCD keypad (6805) during programming operations. **NOTE:** Actual keypad programming should be performed after completion of the programming sheet.

Entering Programming Mode via Either LED or LCD Keypads

The SYSTEM programming mode can be entered WHILE DISARMED ONLY as follows:

TO ENTER INSTALLER PROGRAMMING: [CODE][*][INSTALLER][1]

Where:

- [CODE] Press the CODE button
- [*] Press the asterisk (*) button
- [INSTALLER] Enter the 4 DIGIT INSTALLER CODE (default = 2468)
- [1] Press "1" button. This indicates Installer Mode 1.

What You See on the LED Keypad

Program Mode = READY LED:

Upon entering the installer keypad programming mode the READY LED will slowly pulse, and will continue to pulse until leaving this mode. The remaining LEDs display the question number and location contents as indicated below:

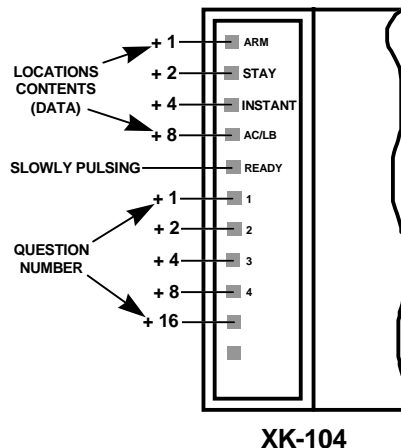

Question Numbers = Zone LEDs

There are 20 total questions, with multiple data entry locations.

Zone LEDs 1 through 5 display the current QUESTION NUMBER (not the specific location within each question) as follows:

In the diagram shown on the following page, the **question number** is the total you get when you ADD the values of all LEDs that are ON.

EXAMPLES:

- Zone 1 ON, Zones 2-5 OFF = QUESTION 01
- Zone 1 ON, Zone 2 ON, Zones 3-5 OFF = QUESTION 03
- Zone 2 ON, Zone 3 ON, Zone 4 ON, Zones 1 and 5 OFF = QUESTION 14

Location Contents = System Status LEDs

The remaining status LEDs (ARM, STAY, INSTANT, AC/LB) display the DATA that resides in EACH location within the **current** question. As per the diagram which follows and explanation above, the value located next to each LED must be ADDED to calculate the total data, for each location.

EXAMPLES:

- Arm ON, Stay, Instant, and AC/LB OFF = 1
- Arm ON, Stay ON, Instant and AC/LB OFF = 3

The following chart displays binary values that you will see on these LEDs for the letters A-F which may be entered in some locations of the program sheet.

- A 10 Stay & AC/LB = ON
- B 11 Arm, Stay, & AC/LB = ON
- C 12 Instant, & AC/LB = ON
- D 13 Arm, Instant, & AC/LB = ON
- E 14 Stay, Instant, & AC/LB = ON
- F 15 Arm, Stay, Instant, & AC/LB = ON

What You See On The LCD Keypad

Upon entering the installer keypad programming following display will appear:

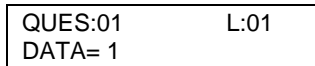

The display shows the current question number (QUES), the location within the question (L:) and the current value within that location (DATA =). This corresponds to the programming worksheet.

How to Enter Data

This section of the manual describes the physical keystrokes to enter the data written on the program sheet.

Movement Between Questions System program mode starts with question 1 displayed. RANDOM JUMPS TO ANY QUESTION CAN BE MADE BY PRESSING THE * (ASTERISK) BUTTON AND THE 2 DIGIT QUESTION NUMBER.

Questions can be accessed randomly or sequentially.

Example: Jump to question 07= Press * 0 7

The proper question number will be displayed by the zone LEDs and the other status LEDs will display the contents of the FIRST location in that question.

Movement Within Questions The zone LEDs display the question number and the other status LEDs display the contents (data) within each location. MOVEMENT FROM LOCATION L1 TO THE NEXT LOCATION WITHIN ANY QUESTION CAN BE PERFORMED BY PRESSING THE # (POUND) BUTTON.

The other status LEDs will display the contents of each location as this button is pressed.

Data Entry To alter the value in any location, enter the desired DIGIT from the program sheet, and press the # button.

NOTE: THE # BUTTON **MUST** BE PRESSED AFTER THE ENTRY OF the DESIRED DIGIT. THE SYSTEM WILL NOT PROGRAM THE DIGIT UNTIL THE POUND (#) BUTTON IS PRESSED, THEREFORE IF A MISTAKE IS MADE IT CAN BE CHANGED.

Numeric entries 0-9 can be performed by pressing the respective keypad button. Entries of A-F require 2 keystrokes as follows

Press the CODE button followed by 1-6 for values A-F.

<u>VALUE</u>	<u>KEYSTROKES</u>	<u>VALUE</u>	<u>KEYSTROKES</u>
A	CODE 1	D	CODE 4
B	CODE 2	E	CODE 5
C	CODE 3	F	CODE 6

Example: Enter an A = Press CODE followed by 1.

Exit System Program Mode After all programming has been completed, PRESS THE **STAY** BUTTON TO EXIT THE SYSTEM PROGRAM MODE. All the LEDs will turn ON for approximately 10 seconds, before the system returns to normal daily operation.

Question Acknowledgment The keypad will beep between keystrokes. In addition, a beep will be generated confirming advancement between question numbers.

Four beeps will be generated if an invalid input is entered. Upon entry of invalid input you are positioned at the same question number and location as prior to the input error.

Summary of System Programming

TO ENTER PROGRAMMING
[CODE] [] [4 digit Installer Code] [1]*

TO SKIP TO A QUESTION
[] {2 digit Question Number}*

TO MOVE WITHIN A QUESTION
Press the [#] until the desired location is reached.

TO ENTER DATA
[single digit: 0 - 9, A - F] [#]

HEXADECIMAL ENTRIES

A = [CODE] [1]	D = [CODE] [4]
B = [CODE] [2]	E = [CODE] [5]
C = [CODE] [3]	F = [CODE] [6]

TO EXIT PROGRAMMING:
Press the [STAY].

System Defaults

The system is shipped from the factory programmed with default values. These values have been selected to meet the requirements of a common installation and may suit your needs.

To reload the factory default values, remove all power from the system (AC & DC). Next short JP1 to JP2, with short still intact reapply power (AC then DC), wait 5 seconds then remove short with the power still applied. The installer can also do a System Default or User Code Default through Installer Mode 1 (refer to the Installer Modes section of this manual).



A programming option exists within the EZ- Mate PC Downloader devices known as DEFAULT LOCKOUT. If this option is selected then a system default will not overwrite the CSID or installer code portion of the program. This will prevent an installer other than the original installer from taking over an account without cooperation.

QUESTION	DEFAULT VALUE
00 Installer Code	2468
01 Primary Telephone Number	234AAAAAAAAA
02 Secondary Telephone Number	AAAAAAAAAAAA
03 Callback Number	AAAA
04 Dialer Options	1601
05 Keypad Conditions	127C
06 System Timeouts	665F
07 Miscellaneous System Options	2605
08 Account Number 1	1234
09 Account Number 2	AAAA
10 Zone 1 Type & CS Code	2031
11 Zone 2 Type & CS Code	4032
12 Zone 3 Type & CS Code	1033
13 Zone 4 Type & CS Code	1034
14 CS Test Offset	083B
15 CS Codes for Ambush/AC Loss	AAAA
16 CS Codes for Panic/Low Battery	22AA
17 CS Codes for Open/Close & CS Test	AAAA
18 CS Codes for Bypass, Restore, Trouble & Cancel	AAF8
19 CS Codes for Keypad Fire & Auxiliary	AAAA

USER NUMBER	DEFAULT CODE	APPLICATION
1	1234	Master User
2	NULL	Normal User
3	NULL	Normal User
4	NULL	Normal User
5	NULL	Normal User
6	NULL	Ambush

Summary of Keypad Functions

User Functions

ARMING/DISARMING:	[4-digit user code]
STAY ARMING:	[STAY] [4-digit user code]
STAY/INSTANT ARMING:	[STAY] [INSTANT] [4 digit user code]
BYPASS:	[BYPASS] [4 digit user code] [Zone #]
USER CODE PROGRAMMING:	[CODE] [Master user code] [user #] [4 digit user code]
USER CODE DELETION:	[CODE] [Master user code] [user #] [*]
PANIC:	[*] & [#] at the same time
AMBUSH:	[Enter user code 6]

Installer Mode

KEYPAD PROGRAMMING:	[CODE] [*] [Enter installer code] [1]
SYSTEM DEFAULT:	[CODE] [*] [Enter installer code] [1] then press [1] & [3] at the same time
USER CODE DEFAULT:	[CODE] [*] [Enter installer code] [1] then press [7] & [9] at the same time



All these functions can be performed from all keypad types (XK-104 or 6805) if they are enabled.

Central Station Reporting Formats

This security system is designed to transmit data to a Central Station Receiver when an Alarm, System Trouble, or an Opening/Closing occurs. Due to the many different types of CS receivers in the market, this system can transmit data in various formats. Each installing company determines which format best suits its needs based on many factors. Of these, the CS receiver type is a major factor.

In transmitting data to the CS receiver, the first event that occurs is that the system's digital communicator will seize the home phone lines. Then, it will dial the CS#1 telephone number (programming question #01). When the CS receiver picks up the ringing phone line, it will transmit a "Handshake" frequency (either 1400Hz, 2300Hz or HiLo) back to the digital communicator. After receiving the "Handshake" frequency, the digital communicator will transmit the data in the format programmed in question #04, locations 1, 2 & 3 (either in Pulse or DTMF). Assuming the CS receiver verifies the data transmission as valid (after 2 successful rounds of data or 1 valid parity round), it will transmit a "Kissoff" frequency back to the digital communicator. This causes the communicator to stop transmitting, unless more data is available, in which case additional data transmissions and "Kissoffs" will occur. After the final "Kissoff", the CS receiver will release the phone line and process the data to its display and associated peripherals (computer and printer). If for any reason the digital communicator does not receive the "Kissoff", it will proceed to dial the CS#2 telephone number or dial again the CS#1 telephone number (if CS#2 is not used). It will continue to dial (8 times for each CS telephone number programmed) until a "Kissoff" is received. If after dialing 8 times for each CS Telephone number programmed a "Kissoff" is not received, the system will display "Communication Failure" at the keypad. This message is cleared after the next successful transmission or by the user at the keypad.

Standard (3X1)

The Standard Reporting Format: AAA E

Where:

AAA = Three digit Account Number (PROG. QUESTS. #08 & 09)

E = Single digit Event code; it is the first of the 2 programmable reporting code digits

Standard format is transmitted in Pulse and involves a 3-digit account number followed by a single digit event code. It can be transmitted with parity (1 round of data) or without parity (2 rounds of data). A disadvantage of this format is that it can only transmit a total of 15 event codes (0 - 9, B - F) without identifying zones or users. Examples:

3X1 W/O PARITY

123 3 (1st round)

123 3 (2nd round)

123 3 (resulting data)

3X1 W/PARITY

123 3 6 (single round)

123 3 (resulting data)



Parity is a number derived automatically by the dialer utilizing a mathematical formula (modulo 15). Ex: 123 3 adds up to 9. This is subtracted from the next highest multiple of 15; in this case, 15 - 9 = 6. If the CS receiver accepts a valid parity digit, it considers the data transmission valid, delivers a "Kissoff" and processes the data. The parity digit is **not** displayed. Its only purpose is for validation of data transmitted. It is not a programmable digit; it is generated automatically by the dialer when the parity option is selected in programming question #04, location 2. The obvious advantage of using parity is speed. The transmission time between dialer and receiver is shorter because fewer digits are transmitted with it as opposed to without it.

4X2

The 4X2 Reporting Format: AAAA EZ

Where:

AAAA = Four digit Account Number (PROG. QUESTS. #08 & 09)

E = Single digit Event code; it is the first of the 2 programmable reporting code digits

Z = Zone or User identifier; it is the second of the 2 programmable reporting code digits

This format is also in Pulse and is an alternative to the Extended format; it also transmits a 2 digit reporting code. Its specific meaning is a 4-digit account number followed by a 2-digit alarm code. It can be transmitted with parity (1 round of data) or without parity (2 rounds of data). There are 15 possible event codes, each of which can have 15 different zone identifiers. As a result, a total of 225 individual events can be reported. It is different from the extended format in the way it transmits. This is illustrated in the examples below:

4X2 W/O PARITY

1234 31 (1st round)

1234 31 (2nd round)

1234 31 (resulting data) Burglary Zone 1

4X2 W/PARITY

1234 31 5 (1st round)

1234 31 (resulting data) Burglary Zone 1

Troubleshooting

SYMPTOM	POSSIBLE CAUSE	REMEDY
1. LED or LCD: Keypad display not lit.	1a. AC & DC power out. 1b. Keypad not powered.	1a. Check transformer connection & battery connection: check AC input volt. & batt. Volt. (with transformer disconnected); check aux. fuse. 1b Check term. 12(+) & 9(-) for 12 VDC.
2. LED KP: "AC/LB" slowly blinking. LCD KP: "LOW BAT"	2a. AC power out 2b. Faulty keypad	2a. Check transformer connection; check AC input. 2b. Replace keypad.
3. LED KP: "AC/LB" slowly blinking. LCD KP: "LOW BAT"	3a. DC power out; no battery connected. 3b. Low battery voltage.	3a. Check battery connection; check battery voltage (w/transformer disconnected); check battery fuse. 3b. Same as 3a, except voltage >11 VDC; otherwise let battery charge; replace battery.
4. LED KP: "ARM" light slowly blinking. LCD KP: "COMM FAILURE"	4a. Failure to communicate with central station. 4b. Faulty panel. 4c. Faulty telephone lines.	4a. Telephone lines cut or disconnected; CS information programmed incorrectly. 4b. Replace panel. 4c. Consult telephone company.
5. LED KP: "ARM" light ON & "READY" light OFF. LCD KP: "NOT RDY:ZN #" & "SYSTEM NOT READY"	5a. Zone faulted/System not ready to be armed. 5b. Faulty keypad. 5c. Faulty panel.	5a. Check loop wiring for an open or short & repair; bad resistor or wrong resistor value. 5b. Replace keypad. 5c. Check zone terminals for 3.3 VDC; Bypass zone temporarily; Replace panel.

For more complicated problems, consult out Technical Service Department at (800) 645-5430.

XL-1S System Planning Worksheet

NAME: _____ ADDRESS: _____

ZONE NUMBER	AREA PROTECTED	ZONE TYPE*	DESCRIPTOR (12 CHARACTERS)	SENSORS
1				
2				
3				
4				
5	Panic <input type="checkbox"/> Keyswitch <input type="checkbox"/>	Not Applicable		

* Valid Zone Types are:

Controlled Zones	24 Hour Zones
Instant/Perimeter	24 Hour Alarm
Delay	24 Hour Trouble
Interior	Fire

USER NUMBER	APPLICATION	USER NAME
1	Master User*	
2	Normal User	
3	Normal User	
4	Normal User	
5	Normal User	
6	Ambush Y <input type="checkbox"/> N <input type="checkbox"/>	

* Only the master user (1) can add, change or delete other user codes.

KEYPAD NUMBER	KEYPAD TYPE	LOCATION
1	XK104 <input type="checkbox"/> 6805 <input type="checkbox"/>	
2	XK104 <input type="checkbox"/> 6805 <input type="checkbox"/>	
3	XK104 <input type="checkbox"/> 6805 <input type="checkbox"/>	
4	XK104 <input type="checkbox"/> 6805 <input type="checkbox"/>	
5	XK104 <input type="checkbox"/> 6805 <input type="checkbox"/>	
6	XK104 <input type="checkbox"/> 6805 <input type="checkbox"/>	

XL-1S System Programming Worksheet

NAME: _____ ADDRESS: _____

01 PRIMARY TELEPHONE NUMBER DEFAULT = 234AAAAAAAAA

L1	L2	L3	L4	L5	L6	L7	L8	L9	L10	L11	L12
----	----	----	----	----	----	----	----	----	-----	-----	-----

02 SECONDARY TELEPHONE NUMBER DEFAULT = AAAAAAAAAAAA

L1	L2	L3	L4	L5	L6	L7	L8	L9	L10	L11	L12
----	----	----	----	----	----	----	----	----	-----	-----	-----

03 CALLBACK TELEPHONE NUMBER DEFAULT = AAAAAAAAAAAA

L1	L2	L3	L4	L5	L6	L7	L8	L9	L10	L11	L12
----	----	----	----	----	----	----	----	----	-----	-----	-----

04 DIALER OPTIONS DEFAULT = 1601

L1	L2	L3	L4
----	----	----	----

05 KEYPAD CONDITIONS DEFAULT = 127C

L1	L2	L3	L4
----	----	----	----

06 SYSTEM TIMEOUTS DEFAULT = 665F

L1	L2	L3	L4
----	----	----	----

07 MISC. SYS. OPTIONS DEFAULT = 2605

L1	L2	L3	L4
----	----	----	----

08 ACCOUNT # 1 DEFAULT = 1234

L1	L2	L3	L4
----	----	----	----

09 ACCOUNT # 2 DEFAULT = AAAA

L1	L2	L3	L4
----	----	----	----

10 ZONE 1 TYPE AND CS CODE DEFAULT = 2031

L1	L2	L3	L4
----	----	----	----

11 ZONE 2 TYPE AND CS CODE DEFAULT = 4132

L1	L2	L3	L4
----	----	----	----

12 ZONE 3 TYPE AND CS CODE DEFAULT = 1033

L1	L2	L3	L4
----	----	----	----

13 ZONE 4 TYPE AND CS CODE DEFAULT = 1034

L1	L2	L3	L4
----	----	----	----

14 CS TEST OFFSET DEFAULT = 083B

L1	L2	L3	L4
----	----	----	----

15 AMBUSH AND AC LOSS DEFAULT = AAAA

L1	L2	L3	L4
----	----	----	----

16 PANIC AND LOW BATTERY DEFAULT = 22AA

L1	L2	L3	L4
----	----	----	----

17 OPEN, CLOSE & CS TEST DEFAULT = AAAA

L1	L2	L3	L4
----	----	----	----

18 BYP, REST, TRBL, & CANC. DEFAULT = AAF8

L1	L2	L3	L4
----	----	----	----

19 KEYPAD FIRE & KEYPAD AUX. DEFAULT = AAAA

L1	L2	L3	L4
----	----	----	----

00 INSTALLER CODE DEFAULT = 2468

L1	L2	L3	L4
----	----	----	----

TO ENTER PROGRAMMING
[CODE] [] [4 digit Installer Code] [1]*

TO SKIP TO A QUESTION
[] {2 digit Question Number}*

TO MOVE WITHIN A QUESTION
Press the [#] until the desired location is reached.

TO ENTER DATA
[single digit: 0 - 9, A - F] [#]
 HEXADECIMAL ENTRIES
 A = [CODE] [1] D = [CODE] [4]
 B = [CODE] [2] E = [CODE] [5]
 C = [CODE] [3] F = [CODE] [6]

TO EXIT PROGRAMMING:
Press the [STAY].

PROGRAMMED BY: _____ DATE: _____

Warnings and Limitations

Warning Limitations of This Alarm System

While this system is an advanced design security system, it does not offer guaranteed protection against burglary, fire or other emergency. Any alarm system, whether commercial or residential, is subject to compromise or failure to warn for a variety of reasons. For example:

- Intruders may gain access through unprotected openings or have the technical sophistication to bypass an alarm sensor or disconnect an alarm warning device.
- Intrusion detectors (e.g., passive infrared detectors), smoke detectors, and many other sensing devices will not work without power. Battery operated devices will not work without batteries, with dead batteries or if the batteries are not put in properly. Devices powered solely by AC will not work if their AC power supply is cut off for any reason, however briefly.
- Signals sent by wireless transmitters may be blocked or reflected by metal before they reach the alarm receiver. Even if the signal path has been recently checked during a weekly test, blockage can occur if a metal object is moved into the path.
- A user may not be able to reach a panic or emergency button quickly enough.
- While smoke detectors have played a key role in reducing residential fire deaths in the United States, they may not activate or provide early warning for a variety of reasons. In as many as 35% of all fires, according to data published by the Federal Emergency Management Agency. Some of the reasons smoke detectors used in conjunction with this System may not work are as follows: Smoke detectors may have been improperly installed and positioned. Smoke detectors may not sense fires that start where smoke cannot reach the detectors, such as in chimneys, in walls, or roofs, or on the other side of closed doors. Smoke detectors may not sense a fire on another level of a residence or building. A second floor detector, for example, may not sense a first floor or basement fire. Moreover, smoke detectors have sensing limitations. No smoke detector can sense every kind of fire every time. In general, detectors may not always warn about fires caused by carelessness and safety hazards like smoking in bed, violent explosions, escaping gas, improper storage of flammable materials, overloaded electrical circuits, children playing with matches, or arson. Depending on the nature of the fire and/or the location of the smoke detectors, the detector, even if it operates as anticipated, may not provide sufficient warning to allow all occupants to escape in time to prevent injury or death.
- Passive Infrared Motion Detectors can only detect intrusion within the designed ranges as diagrammed in their installation manual. Passive Infrared Detectors do not provide volumetric area protection. They do create multiple beams of protection, and intrusion can only be detected in unobstructed areas covered by the beams. They cannot detect motion or intrusion that takes place behind walls, ceilings, floors, closed doors, glass partitions, glass doors, or window. Mechanical tampering, masking, painting, or spraying of any material on the mirrors, windows or any part of the optical system can reduce their detection ability. Passive Infrared Detectors sense changes in temperature; however, as the ambient temperature of the protected area approaches the temperature range of 90 to 150F, the detection performance can decrease.
- Alarm warning devices such as sirens, bells or horns may not alert people or wake up sleepers who are located on the other side of closed or partly open doors. If warning devices sound on a different level of the residence from the bedrooms, then they are less likely to waken or alert people inside the bedrooms. Even persons who are awake may not hear the warning if the alarm is muffled by noise from a stereo, radio, air conditioner or other appliances, or by passing traffic. Finally, alarm warning devices, however loud, may not warn hearing-impaired people or waken deep sleepers.
- Telephone lines needed to transmit alarm signals from a premises to a central monitoring station may be out of service or temporarily out of service. Telephone lines are also subject to compromise by sophisticated intruders.
- Even if the system responds to the emergency as intended, however, occupants may have insufficient time to protect themselves from the emergency situation. In the case of a monitored alarm system, authorities may not respond appropriately.
- This equipment, like other electrical devices, is subject to component failure. Even though this equipment is designed to last as long as 10 years, the electronic components could fail at any time.

The most common cause of an alarm system not functioning when an intrusion or fire occurs is inadequate maintenance. This alarm system should be tested weekly to make sure all sensors are working properly. Installing an alarm system may make

XL-1S Hookup and Installation Instructions

one eligible for lower insurance rates, but an alarm system is not a substitute for insurance. Homeowners, property owners and renters should continue to act prudently in protecting themselves and continue to insure their lives and property.

We continue to develop new and improved protection devices. Users of alarm systems owe it to themselves and their loved ones to learn about these developments.

FCC Statement and Telephone Problems

Federal Communications Commission (FCC) Statement

This equipment has been tested to FCC requirements and has been found acceptable for use. The FCC requires the following statement for your information.

This equipment generates and uses radio frequency energy and if not installed and used properly, that is in strict accordance with the manufacturer's instructions may cause interference to radio and television reception. It has been tested and found to comply with the limits of Part 15 of FCC Rules, which are designed to provide reasonable protection against such interference in a residential installation. However, there is no guarantee that interference will not occur in a particular installation. If this equipment does not cause interference to radio or television reception, which can be determined by turning the equipment off and on, the user is encouraged to try to correct the interference by one or more of the following measures:

- If using an indoor antenna, have a quality outdoor antenna installed.
- Reorient the receiving antenna until interference is reduced or eliminated.
- Move the radio or television receiver away from the control/communicator.
- Move the antenna leads away from any wire runs to the control/communicator.
- Plug the control/communicator into a different outlet so that it and the radio or television receiver are on different branch circuits.

If necessary, the user should consult the dealer or an experienced radio/television technician for additional suggestions.

The user may find the following booklet prepared by the Federal Communications Commission helpful:

Interference Handbook"

This booklet is available from the U.S. Government Printing Office, Washington, DC 20402. Stock No. 004-000-00450-7.

The user shall not make any changes or modifications to the equipment unless authorized by the installation Instructions or User's Manual. Unauthorized changes or modifications could void the user's authority to operate the equipment.

In the Event of Telephone Operational Problems

In the event of telephone operational problems, disconnect the communicator by removing the plug from the RJ31X jack. Do not disconnect the phone connection inside the communicator. Doing so will result in the loss of your phone lines. If the regular phone works correctly after the communicator has been disconnected from the phone lines, the communicator has a problem and should be returned for repair. If upon disconnection of the communicator, there is still a problem on your line, notify the telephone company that they have a problem and request prompt repair service. The user may not under any circumstances (in or out of warranty) attempt any service or repairs on the system. It must be returned to the factory or an authorized service agency for all repairs.

Warranty

FBI Limited Warranty

Fire Burglary Instruments, Inc., a Subsidiary of Pittway Corporation, and Pittway Corporation its divisions, subsidiaries and affiliates ("Seller"), 149 Eileen Way, Syosset, New York 11791 warrants its products to be in conformance with its own plans and specifications and to be free from defects in materials and workmanship under normal use and service for 5 years from the date stamp control on the product, or for products not having a date stamp, for 5 years from the date of original purchase unless the installation instructions or catalog sets forth a shorter period, in which case the shorter period shall apply. Seller's obligation shall be limited to repairing or replacing, at its option, free of charge for materials or labor, any product which is proved not in compliance with Seller's specifications or proves defective in materials or workmanship under normal use and service. Seller shall have no obligation under this Limited Warranty or otherwise if the product is altered or improperly repaired or serviced by anyone other than Seller. For warranty service, return transportation prepaid, to Factory Service, 149 Eileen Way, Syosset, New York 11791.

THERE ARE NO WARRANTIES, EXPRESSED OR IMPLIED, OF MERCHANTABILITY, OR FITNESS FOR A PARTICULAR PURPOSE OR OTHERWISE, WHICH EXTEND BEYOND THE DESCRIPTION ON THE FACE HEREOF. IN NO CASE SHALL SELLER BE LIABLE TO ANYONE FOR ANY CONSEQUENTIAL OR INCIDENTAL DAMAGES FOR BREACH OF THIS OR ANY OTHER WARRANTY, EXPRESS OR IMPLIED, OR UPON ANY OTHER BASIS OF LIABILITY WHATSOEVER, EVEN THE LOSS OR DAMAGE IS CAUSED BY THE SELLER'S OWN NEGLIGENCE OR FAULT.

Seller does not represent that the products it sells may not be compromised or circumvented; that the products will prevent any personal injury or property loss by burglary, robbery, fire or otherwise; or that the products will in all cases provide adequate warning or protection. Customer understands that a properly installed and maintained alarm system may only reduce the risk of a burglary, robbery, fire, or other events occurring without providing an alarm, but it is not insurance or a guarantee that such will not occur or that there will be no personal injury or property loss as a result. CONSEQUENTLY, SELLER SHALL HAVE NO LIABILITY FOR ANY PERSONAL INJURY, PROPERTY DAMAGE OR OTHER LOSS BASED ON A CLAIM THE PRODUCT FAILED TO GIVE ANY WARNING. HOWEVER, IF SELLER IS HELD LIABLE, WHETHER DIRECTLY OR INDIRECTLY, FOR ANY LOSS OR DAMAGE ARISING UNDER THIS LIMITED WARRANTY OR OTHERWISE, REGARDLESS OF CAUSE OR ORIGIN, SELLER'S MAXIMUM LIABILITY SHALL NOT IN ANY CASE EXCEED THE PURCHASE PRICE OF THE PRODUCT, WHICH SHALL BE THE COMPLETE AND EXCLUSIVE REMEDY AGAINST SELLER. This warranty replaces any previous warranties and is the only warranty made by seller on this product. No increase or alteration, written or verbal, on the obligations of this Limited Warranty is authorized.



Copyright © 1998 PITTMAY CORPORATION



N9471V1 06/98